

1 SP 7-23



: 98699193

, EN 1.4301 (AISI 304),

MS40003

40 °C.

MP204

Grundfos Tempcon,
(DOL).

Maximum liquid temperature: 40 °C

.t 0,15 / : 40 °C

: 20 °C

998.2 / ³

: 2900 /

7 ³/

105.5

: HM/CER

: CE,EAC

- : ISO9906:2012 3B

: T40

EN 1.4301

AISI AISI 304

EN 1.4301

AISI AISI 304

DIN W.-Nr. 1.4301

AISI 304

: Rp1 1/2
 : 4 inch
 :
 : MS4000
 - P2: 3
 (2), : 3
 : 50 Hz
 : 3 x 380-400-415
 : 7.70-7.85-8.10 A
 : 450-490-490 %
 Cos - : 0.82-0.77-0.73
 : 2850-2865-2875 /
 :
 (IEC 34-5): IP68
 (IEC 85): F
 :
 : 79195508
 :
 : MEI : 0.70
 ErP : EuP / .
 : 35.3
 : 40.9
 : 0.068 ³
 Danish VVS No.: 388461023

98699193 SP 7-23 50

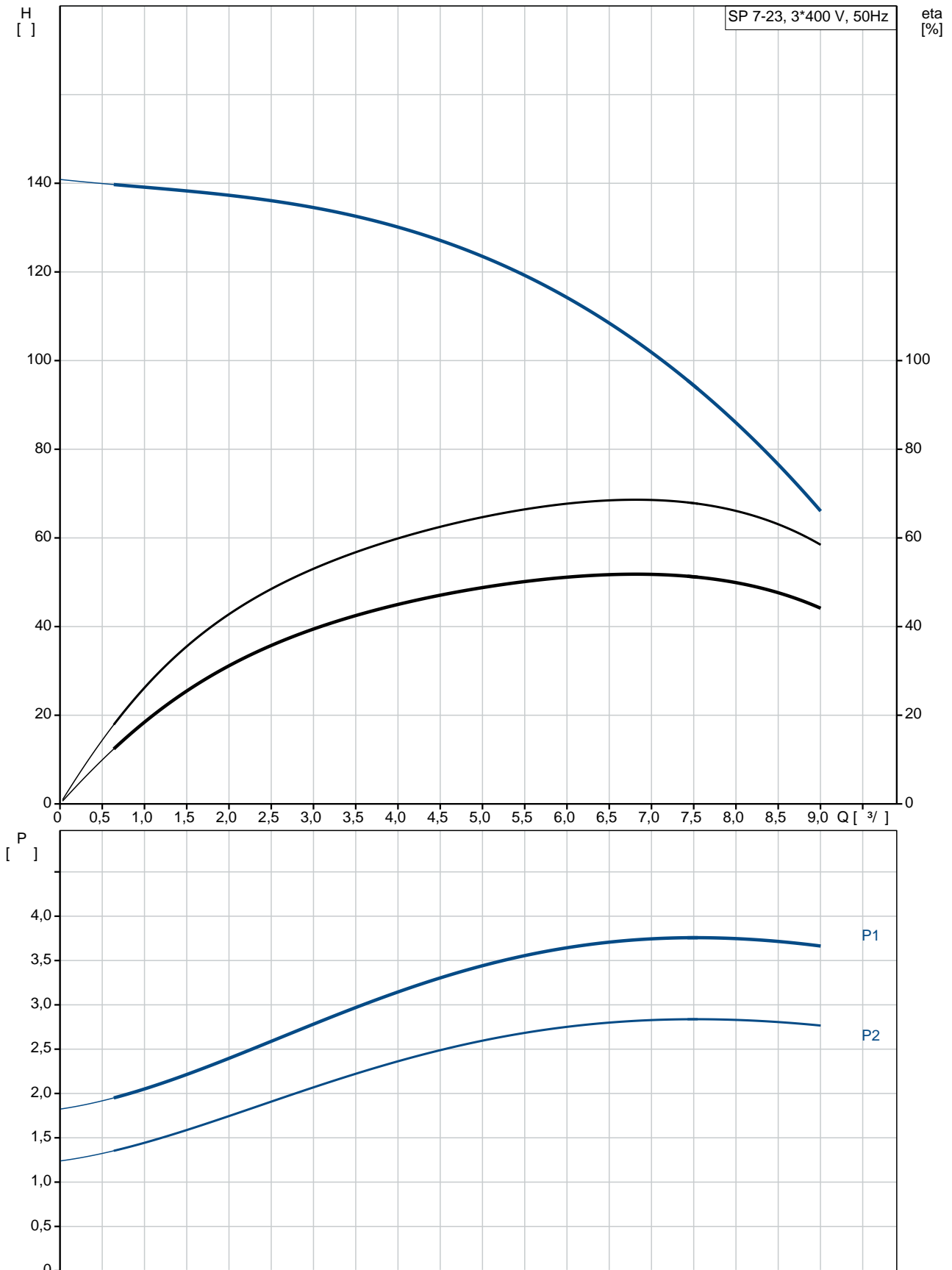

SP 7-23
 EAN : 98699193
 5712600108691

2900 /
 7 3/
 105.5
 23
 NONE
 HM/CER
 CE,EAC
 ISO9906:2012 3B
 A
 YES
 T40

EN 1.4301
 AISI AISI 304
 EN 1.4301
 AISI AISI 304
 DIN W.-Nr. 1.4301
 AISI 304

Rp1 1/2
 4 inch

Maximum liquid temperature: 40 °C
 . t 0,15 / : 40 °C
 20 °C
 998.2 / 3

MS4000
 NEMA
 - P2: 3
 (2), 3

50 Hz
 3 x 380-400-415
 7.70-7.85-8.10 A
 450-490-490 %
 Cos - : 0.82-0.77-0.73
 2850-2865-2875 /

(IEC 34-5): IP68
 (IEC 85): F

79195508

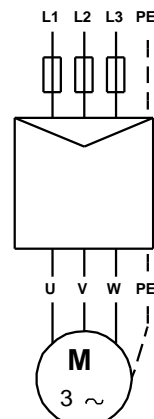
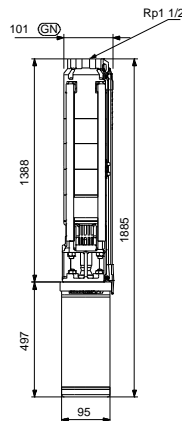
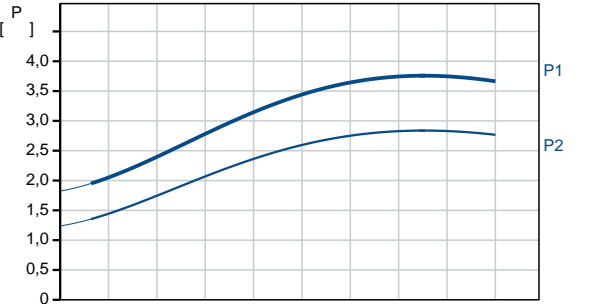
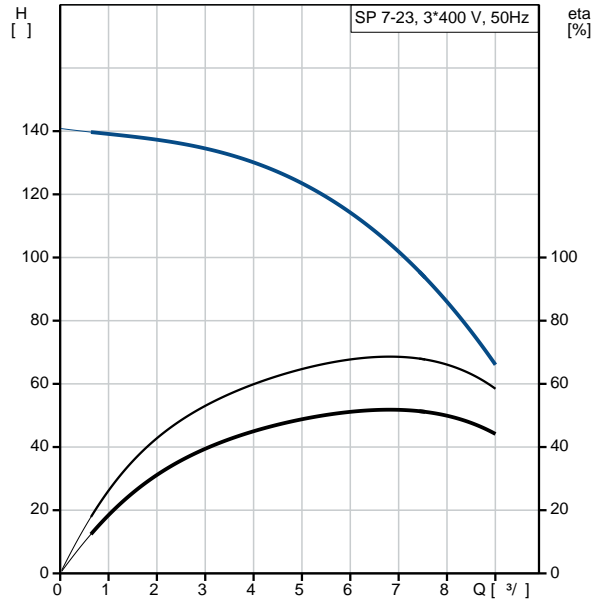

MEI :		0.70
ErP :	EuP	/ .
:		35.3
:		40.9
:		0.068 ³
Danish VVS No.:		388461023

98699193 SP 7-23 50

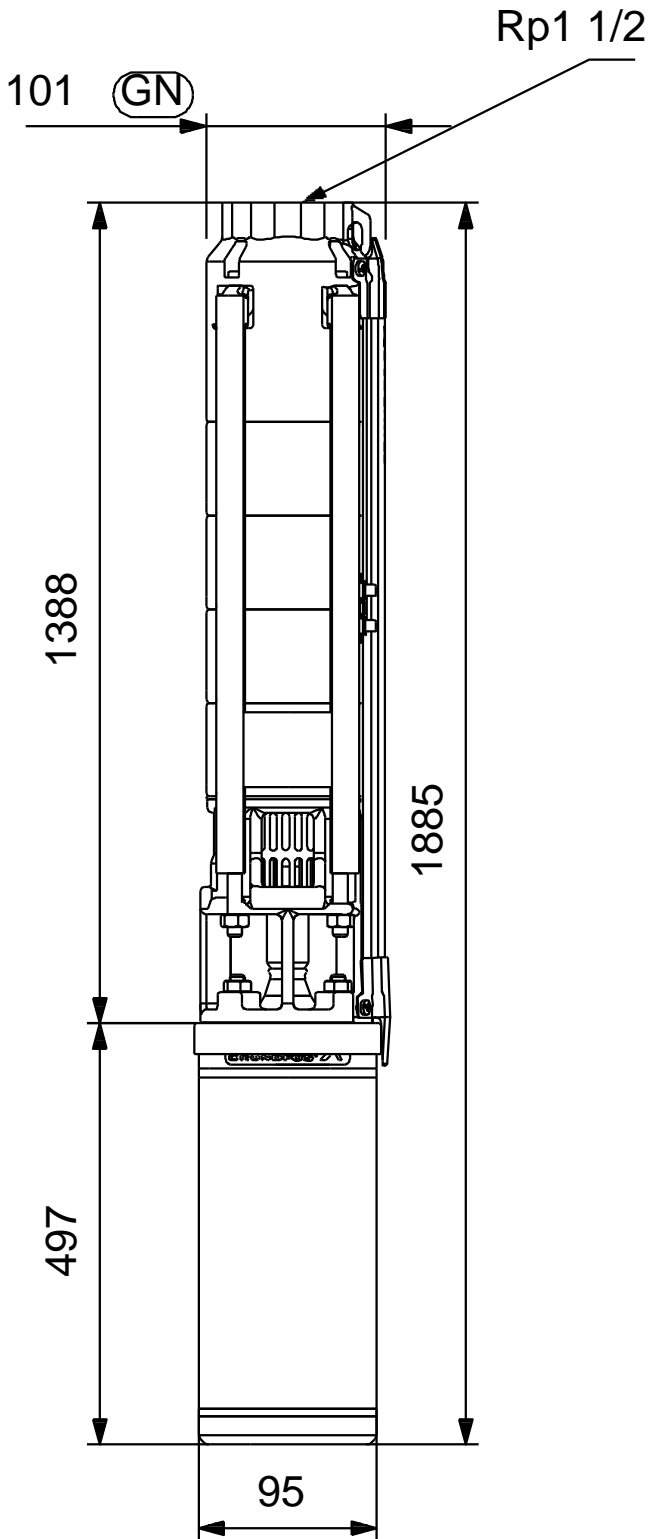

98699193 SP 7-23 50

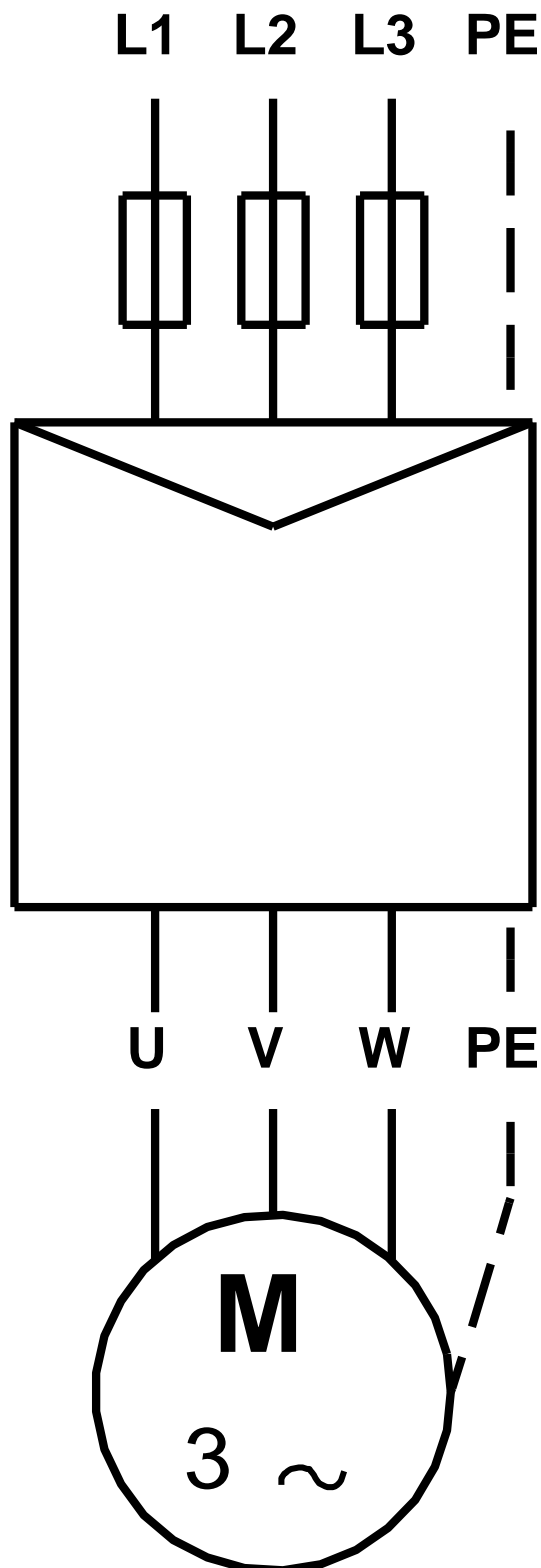

! [], .