

1 SP 7-3



: 98699185

, EN 1.4301 (AISI 304),

MS4020.55

40 °C.

Pt1000.
(DOL).

Maximum liquid temperature: 40 °C
 . t 0,15 / : 40 °C
 : : 20 °C
 : 998.2 / ³

: 2900 /

: 7 ³/₁₃
 :
 : LIPSEAL
 : CE,EAC
 - : ISO9906:2012 3B
 : T40

EN 1.4301
 AISI AISI 304

EN 1.4301
 AISI AISI 304

DIN W.-Nr. 1.4301
 AISI 304

: Rp1 1/2
 : 4 inch
 :
 : MS402
 - P2: 0.55
 (2), : 0.55
 : 50 Hz
 : 3 x 380-400-415
 : 2.00-2.20-2.35 A
 : 470-480-470 %
 Cos - : 0.70-0.64-0.60
 : 2850-2860-2870 /
 :
 (IEC 34-5): IP68
 (IEC 85): B
 :
 : 79192003
 :
 : MEI : 0.70
 ErP : EuP /
 : 11.7
 : 13.2
 : 0.011 ³

98699185 SP 7-3 50

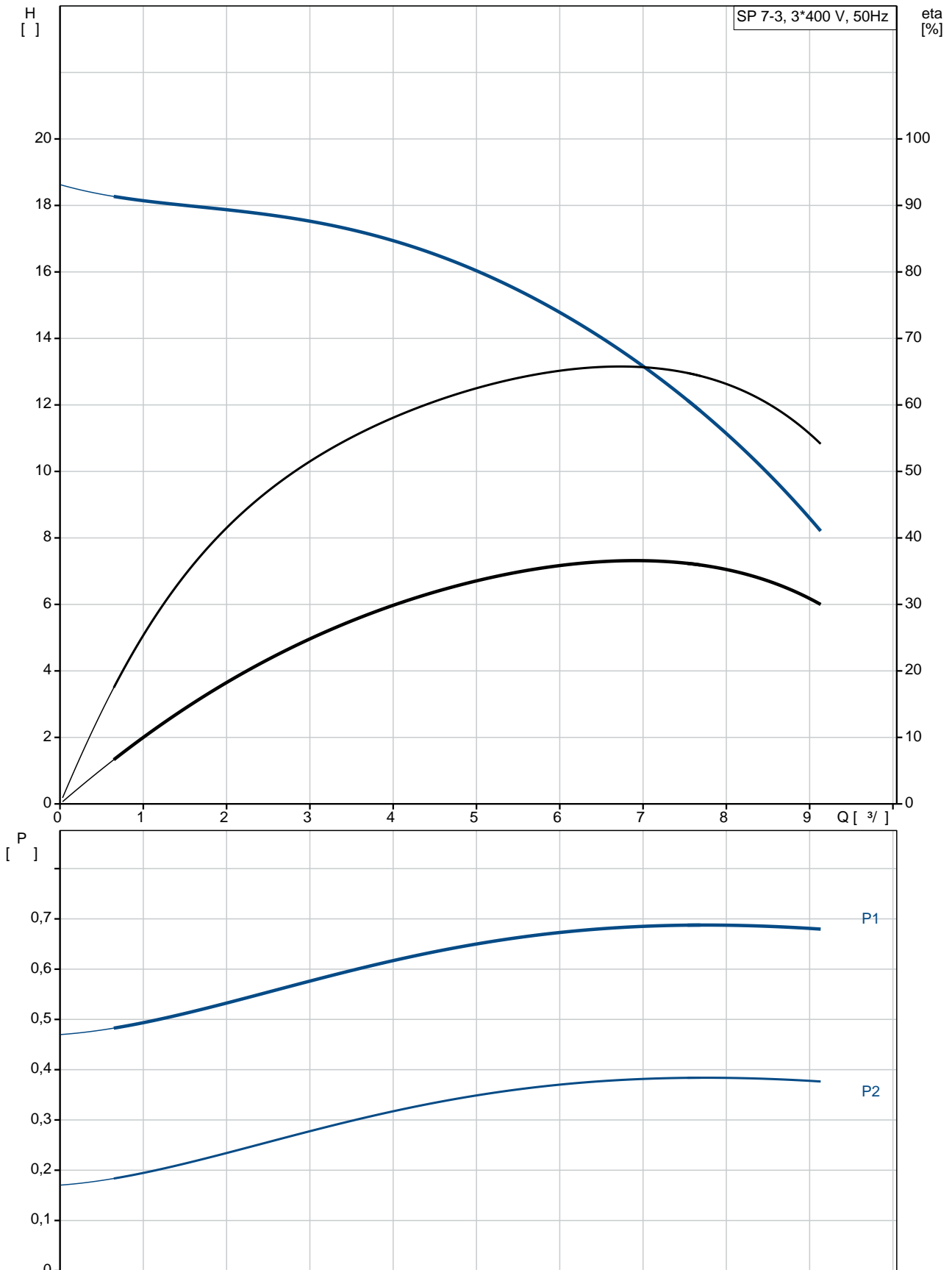

SP 7-3
 EAN : 98699185
 5712600108530
 2900 /
 7 3/
 13
 3
 NONE
 LIPSEAL
 CE,EAC
 ISO9906:2012 3B
 A
 YES
 T40

EN 1.4301
 AISI AISI 304

EN 1.4301
 AISI AISI 304

DIN W.-Nr. 1.4301
 AISI 304

Rp1 1/2
 4 inch

Maximum liquid temperature: 40 °C
 . t 0,15 / : 40 °C
 20 °C
 998.2 / ³

MS402

NEMA

- P2: 0.55

(2), 0.55

50 Hz

3 x 380-400-415

2.00-2.20-2.35 A

470-480-470 %

Cos - : 0.70-0.64-0.60

2850-2860-2870 /

(IEC 34-5): IP68

(IEC 85): B

79192003

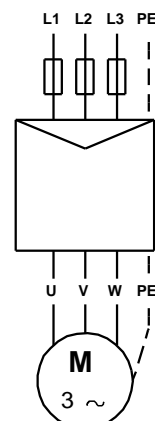
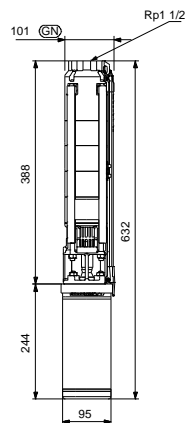
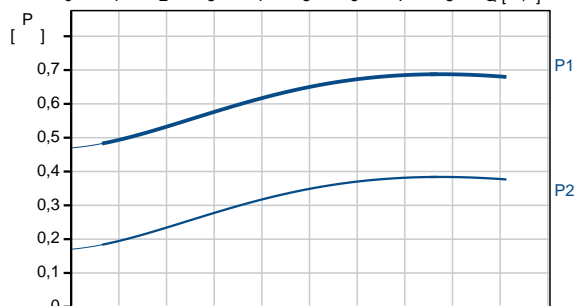
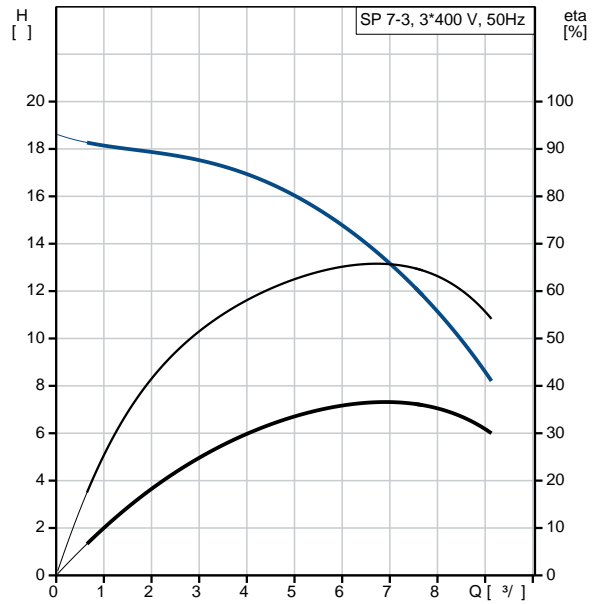

MEI :		0.70
ErP :	EuP	/ .
:		11.7
:		13.2
:		0.011 ³

98699185 SP 7-3 50

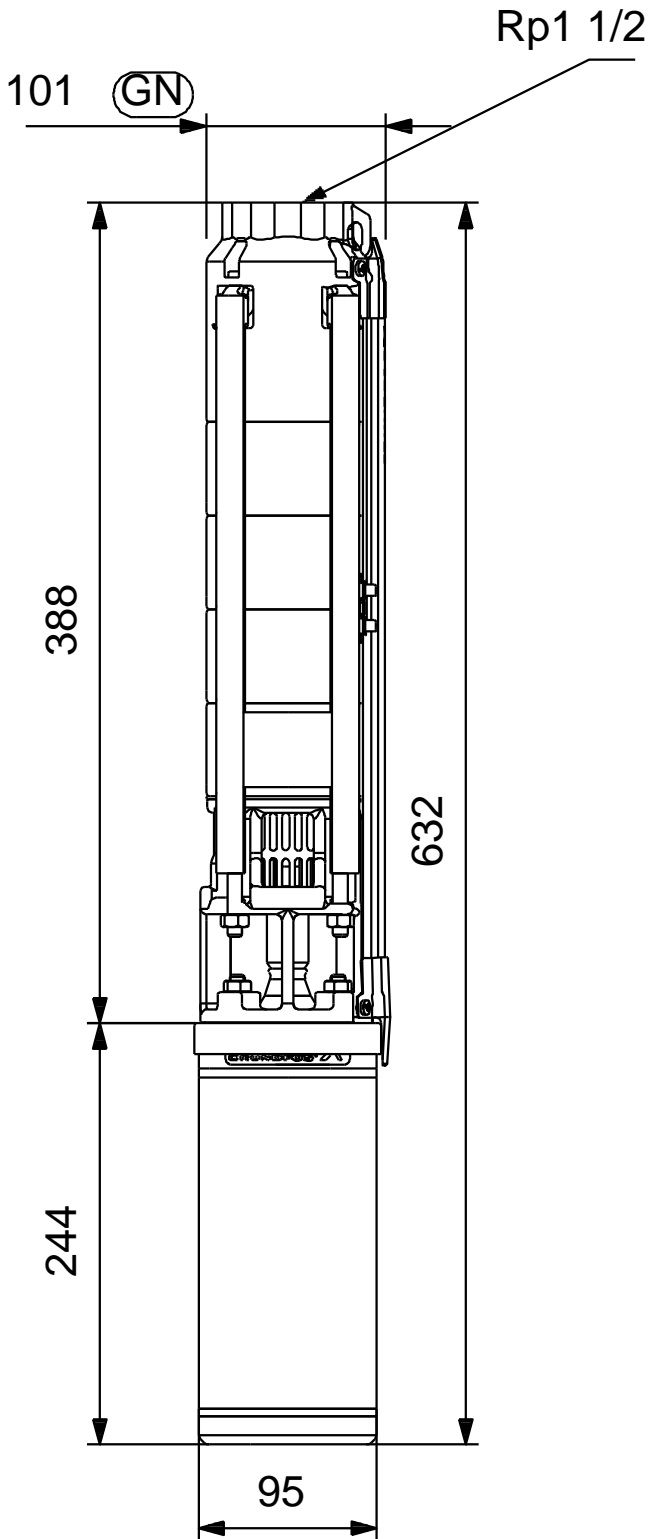

98699185 SP 7-3 50

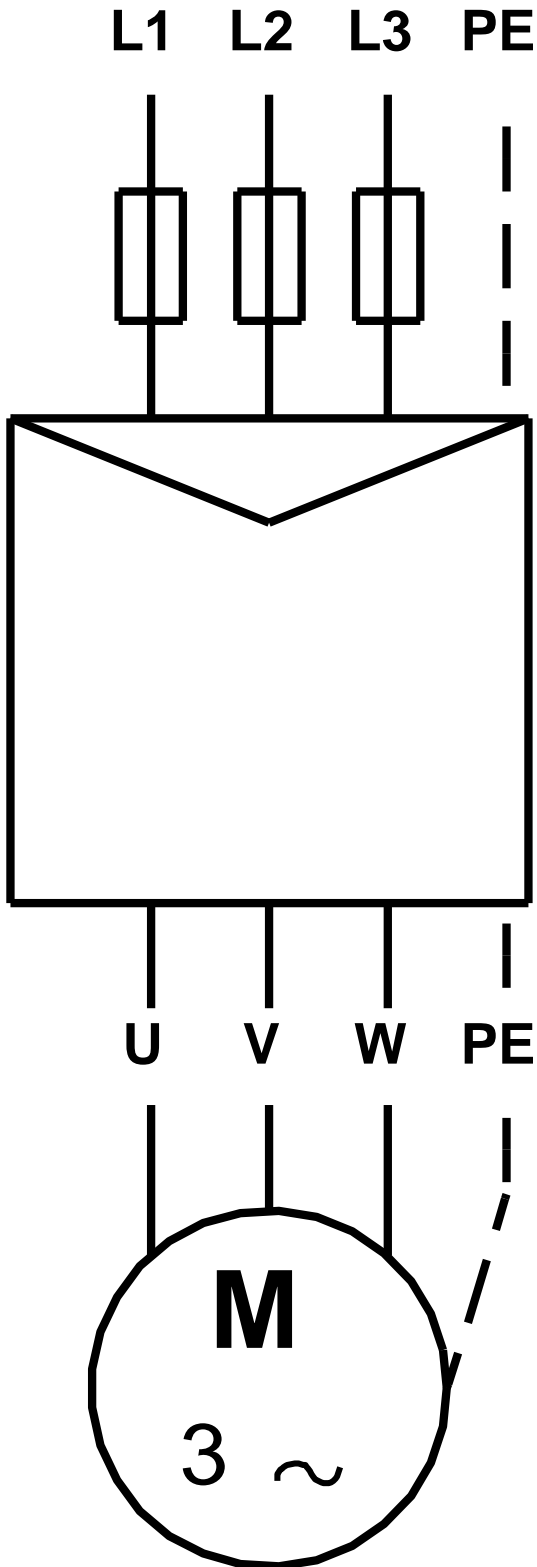

! [], .