

1 SP 7-27



: 98699183

, EN 1.4301 (AISI 304),

MS40004

40 °C.

Pt1000.  
(DOL).

Maximum liquid temperature: 40 °C  
 . t 0,15 / : 40 °C  
 : : 20 °C  
 : 998.2 / <sup>3</sup>

: 2900 /

: 7 <sup>3</sup>/<sub>l</sub>  
 : 124  
 : HM/CER  
 : CE,EAC  
 - : ISO9906:2012 3B  
 : T40

EN 1.4301  
 AISI AISI 304

EN 1.4301  
 AISI AISI 304

DIN W.-Nr. 1.4301  
 AISI 304

: Rp1 1/2  
 : 4 inch  
 :  
 : MS4000  
 - P2: 4  
 ( 2), : 4  
 : 50 Hz  
 : 3 x 380-400-415  
 : 9.75-9.60-9.80 A  
 : 460-500-530 %  
 Cos - : 0.85-0.80-0.77  
 : 2850-2865-2875 /  
 :  
 (IEC 34-5): IP68  
 (IEC 85): F  
 :  
 : 79194510  
 :  
 ErP : MEI : 0.70  
 : EuP / .  
 : 41.6  
 : 75.7  
 : 0.264 <sup>3</sup>  
 Finnish LVI No.: 4762686  
 C : DK  
 : 8413702900

## 98699183 SP 7-27 50

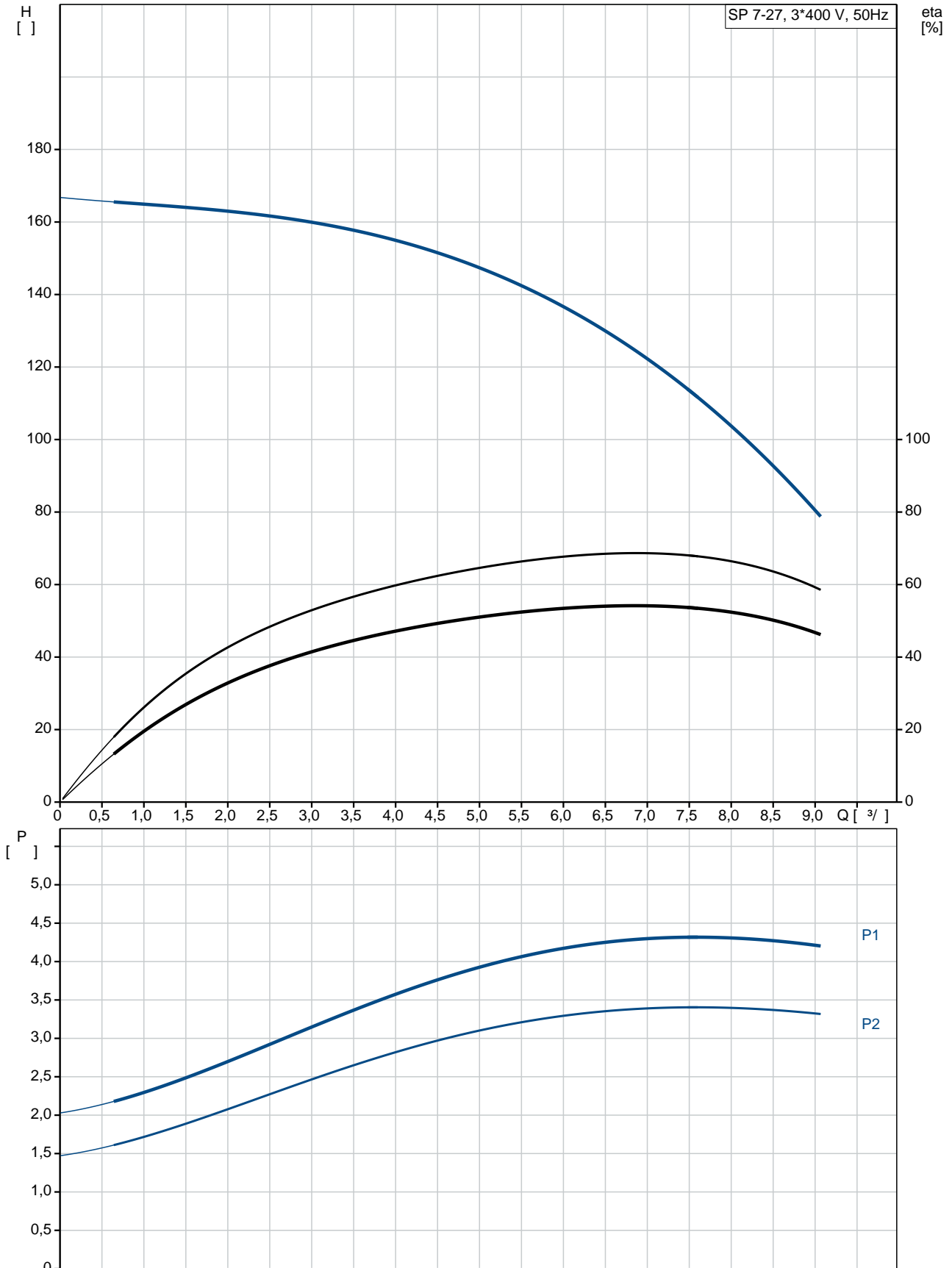

SP 7-27  
 EAN : 98699183  
 5712600108493

2900 /  
 7 3/  
 124  
 27  
 NONE  
 HM/CER  
 CE,EAC  
 ISO9906:2012 3B  
 A  
 YES  
 T40

EN 1.4301  
 AISI AISI 304  
 EN 1.4301  
 AISI AISI 304  
 DIN W.-Nr. 1.4301  
 AISI 304

Rp1 1/2  
 4 inch

Maximum liquid temperature: 40 °C  
 . t 0,15 / : 40 °C  
 20 °C  
 998.2 / 3

MS4000  
 NEMA  
 - P2: 4  
 ( 2), 4

50 Hz  
 3 x 380-400-415  
 9.75-9.60-9.80 A  
 460-500-530 %  
 Cos - : 0.85-0.80-0.77  
 2850-2865-2875 /

(IEC 34-5): IP68  
 (IEC 85): F

79194510

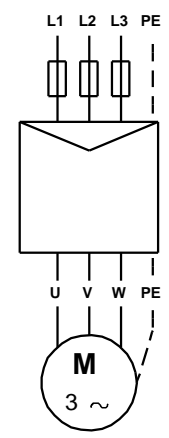
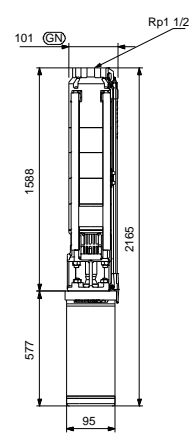
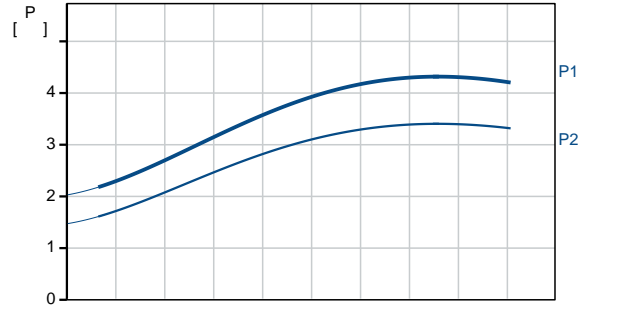
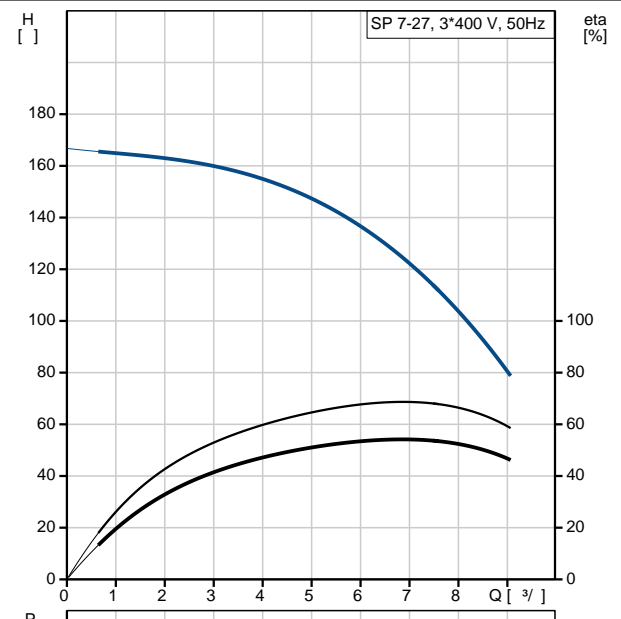

		MEI :	0.70
ErP	:	EuP	/ .
	:	41.6	
	:	75.7	
	:	0.264 <sup>3</sup>	
Finnish LVI No.:		4762686	
C	:	DK	
	:	8413702900	

## 98699183 SP 7-27 50

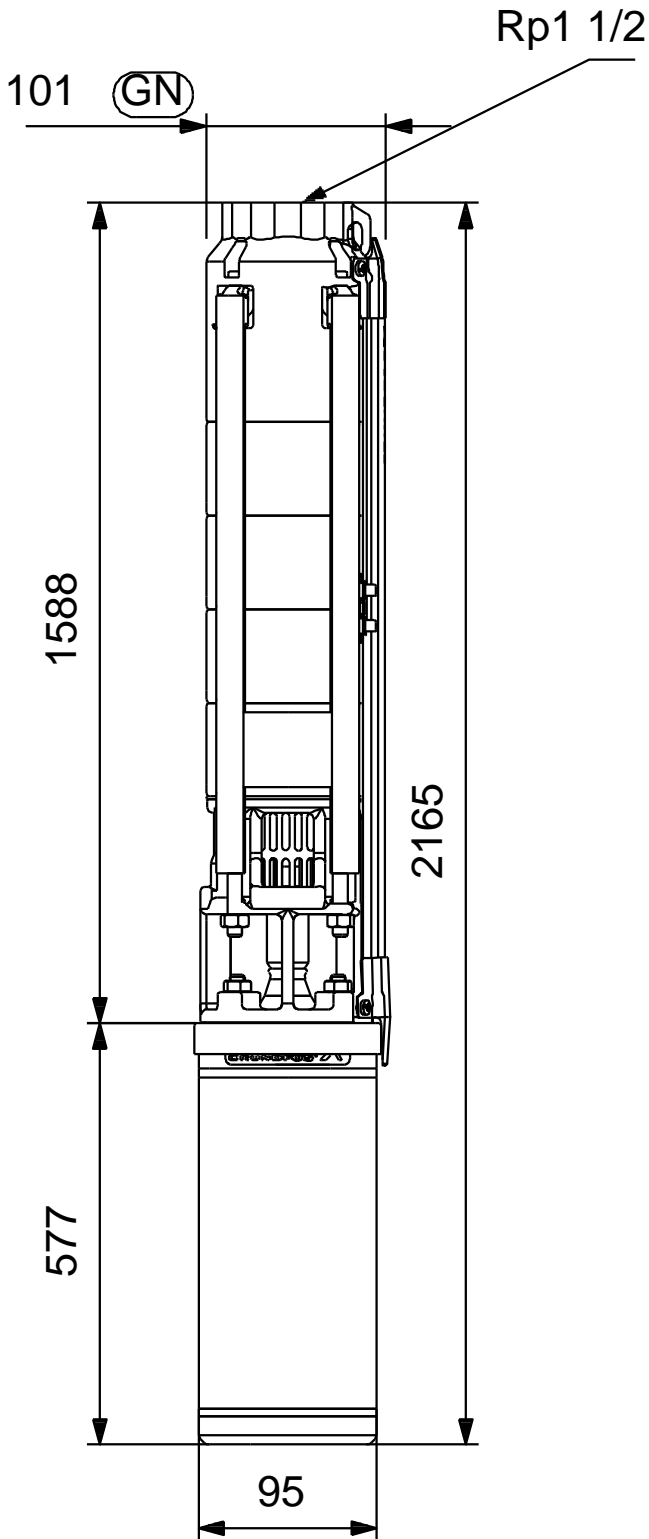

98699183 SP 7-27 50

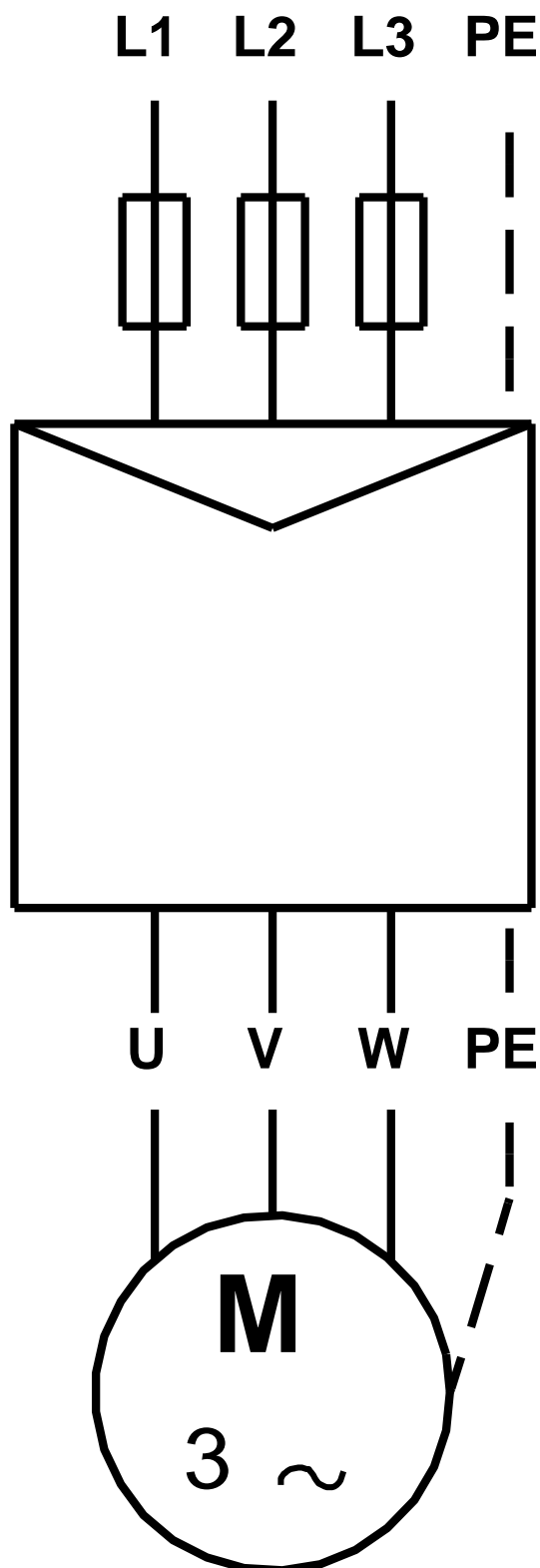

!

[ ],