

1 SP 7-17



: 98699181

, EN 1.4301 (AISI 304),

MS4022.2

40 °C.

Pt1000.  
(DOL).

Maximum liquid temperature: 40 °C  
 . t 0,15 / : 40 °C  
 : : 20 °C  
 : 998.2 / <sup>3</sup>

: 2900 /

: 7 <sup>3</sup>/<sub>l</sub>  
 : 77.8  
 : LIPSEAL  
 : CE,EAC  
 - : ISO9906:2012 3B  
 : T40

EN 1.4301  
 AISI AISI 304

EN 1.4301  
 AISI AISI 304

DIN W.-Nr. 1.4301  
 AISI 304

: Rp1 1/2  
 : 4 inch  
 :  
 : MS402  
 - P2: 2.2  
 ( 2), : 2.2  
 : 50 Hz  
 : 3 x 380-400-415  
 : 5.50-5.50-5.70 A  
 : 440-460-470 %  
 Cos - : 0.85-0.82-0.77  
 : 2850-2860-2870 /  
 :  
 (IEC 34-5): IP68  
 (IEC 85): B  
 :  
 : 79192007  
 :  
 : MEI : 0.70  
 ErP : EuP / .  
 : 26.1  
 : 28.6  
 : 0.021 <sup>3</sup>  
 Danish VVS No.: 388461017  
 Finnish LVI No.: 4762684  
 C : DK  
 : 8413702900

## 98699181 SP 7-17 50

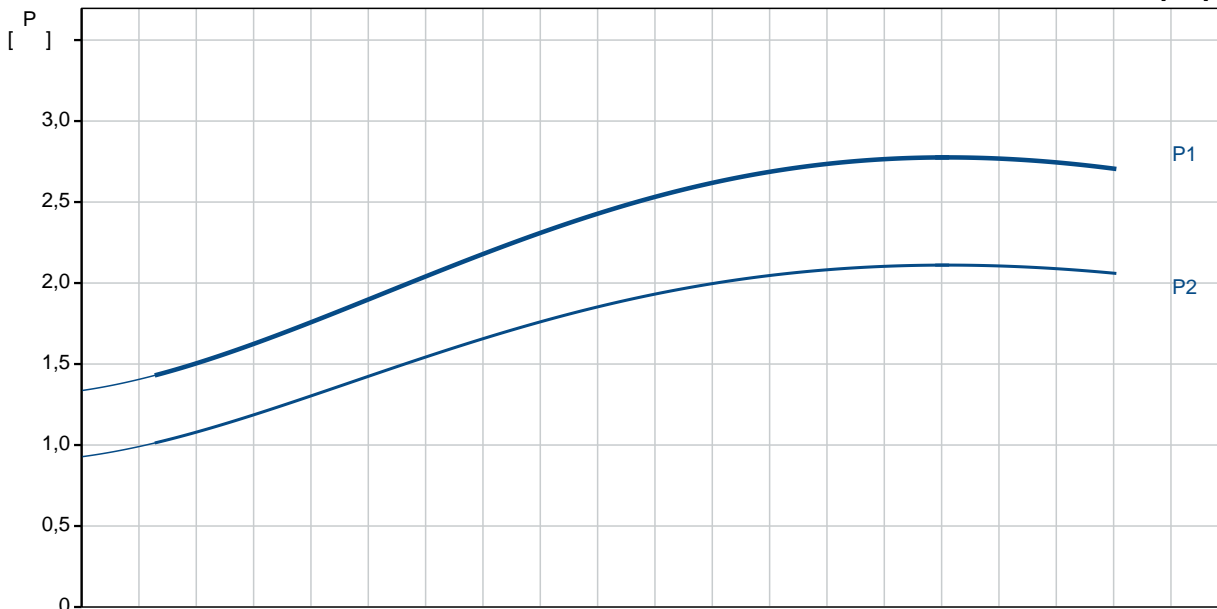
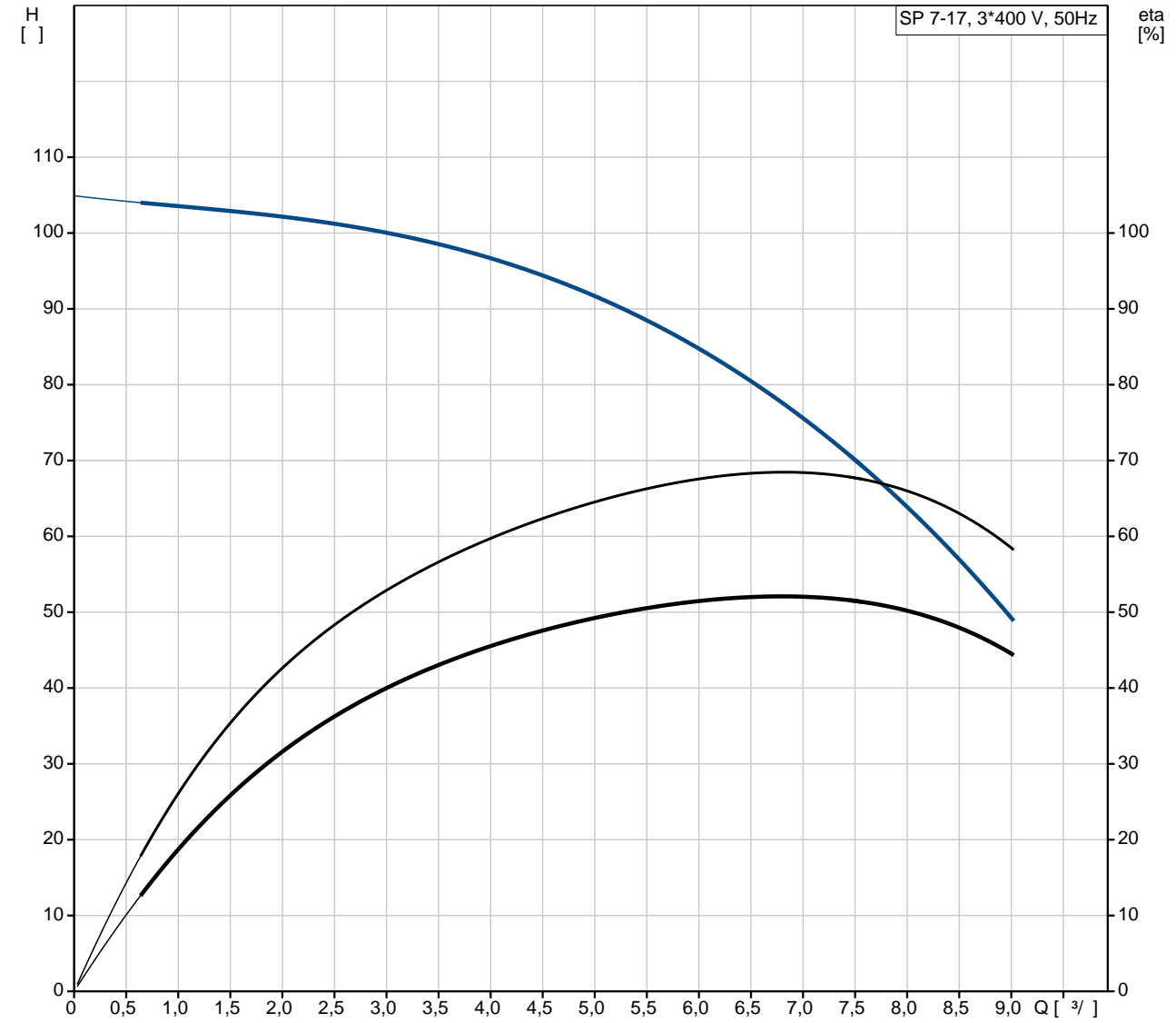

SP 7-17  
 EAN : 98699181  
 5712600108455

2900 /  
 7 3/  
 77.8  
 17  
 NONE  
 LIPSEAL  
 CE,EAC  
 ISO9906:2012 3B  
 A  
 YES  
 T40

EN 1.4301  
 AISI AISI 304  
 EN 1.4301  
 AISI AISI 304  
 DIN W.-Nr. 1.4301  
 AISI 304

Rp1 1/2  
 4 inch

Maximum liquid temperature: 40 °C  
 . t 0,15 / : 40 °C  
 20 °C  
 998.2 / 3

MS402  
 NEMA  
 - P2: 2.2  
 ( 2), 2.2

50 Hz  
 3 x 380-400-415  
 5.50-5.50-5.70 A  
 440-460-470 %  
 Cos - : 0.85-0.82-0.77  
 2850-2860-2870 /

(IEC 34-5): IP68  
 (IEC 85): B

79192007

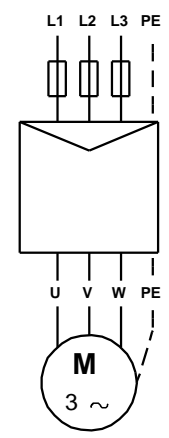
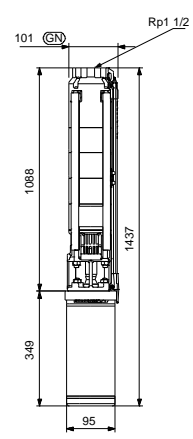
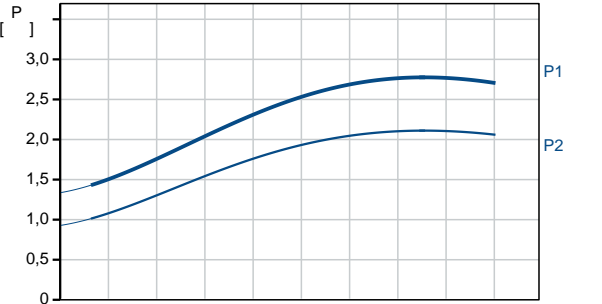
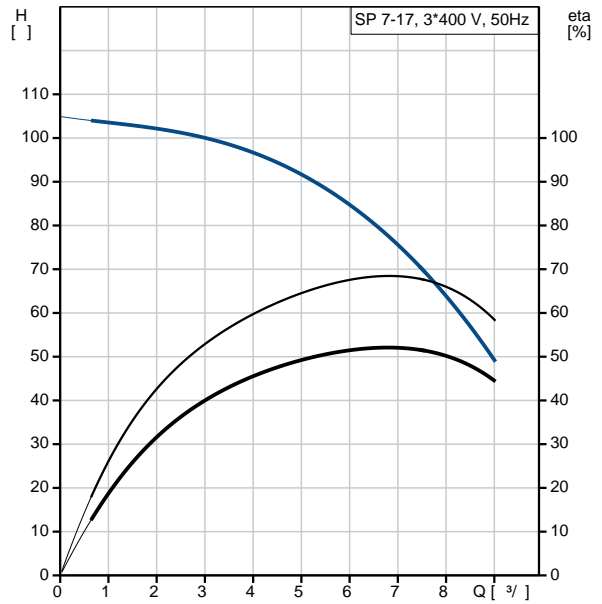

MEI :		0.70
ErP :	EuP	/ .
:		26.1
:		28.6
:		0.021 <sup>3</sup>
Danish VVS No.:		388461017
Finnish LVI No.:		4762684
C :	DK	
:		8413702900

## 98699181 SP 7-17 50

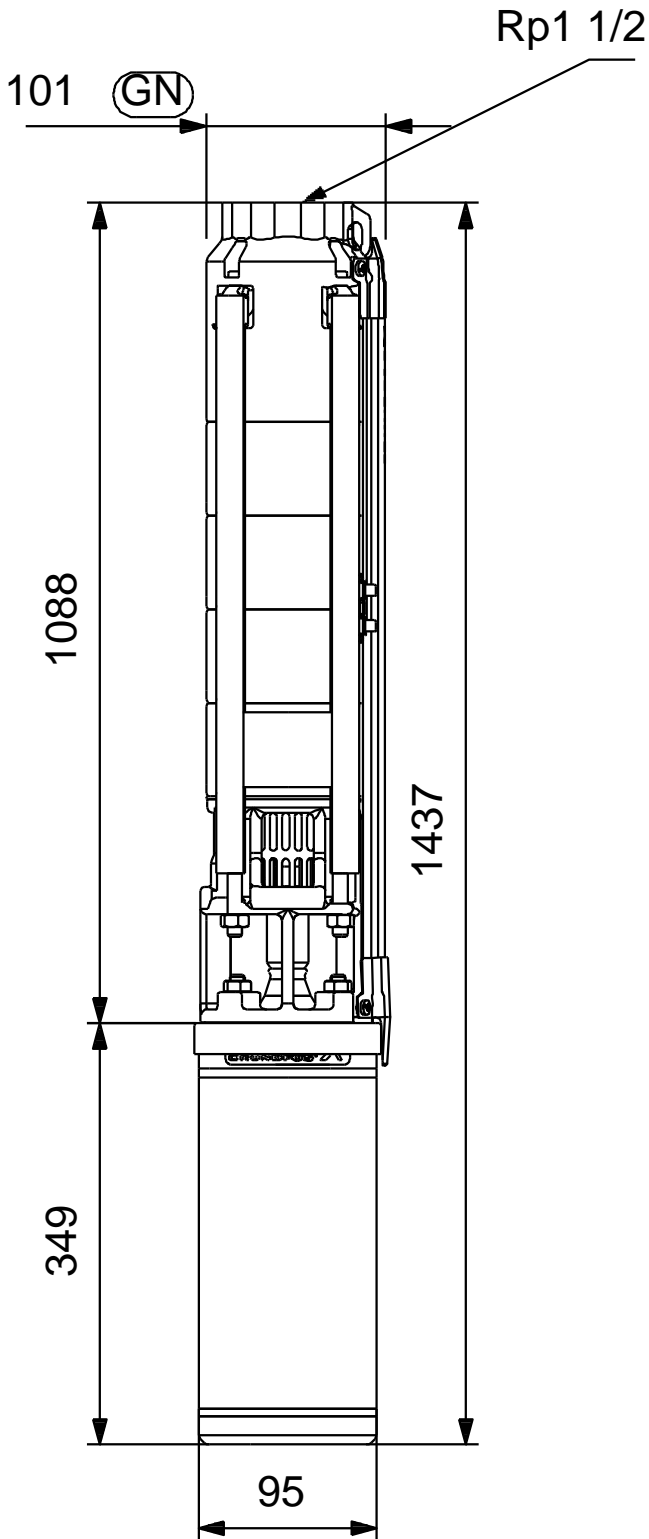

98699181 SP 7-17 50

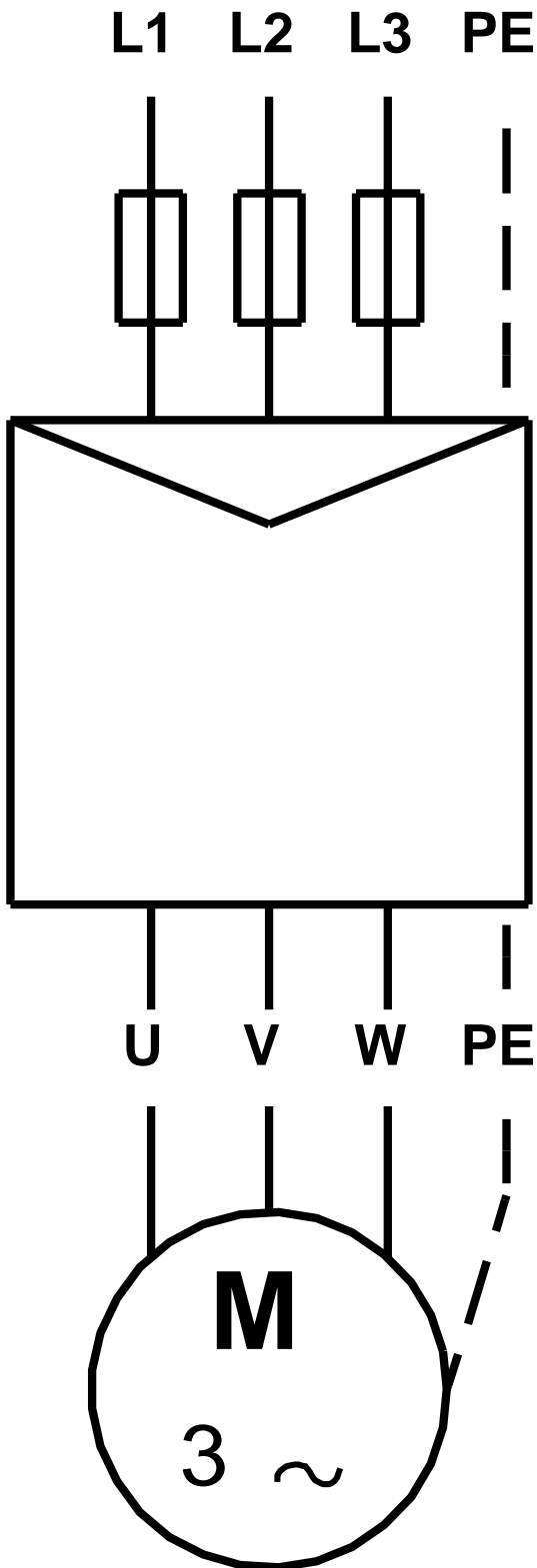

!

[ ],