

1 SP 7-8



: 98699179

, EN 1.4301 (AISI 304),

MS4021.1

40 °C.

Pt1000.
(DOL).

Maximum liquid temperature: 40 °C
 . t 0,15 / : 40 °C
 : : 20 °C
 : 998.2 / ³

: 2900 /

: 7 ³/_l
 : 36.2
 : LIPSEAL
 : CE,EAC
 - : ISO9906:2012 3B
 : T40

EN 1.4301
 AISI AISI 304

EN 1.4301
 AISI AISI 304

DIN W.-Nr. 1.4301
 AISI 304

: Rp1 1/2
 : 4 inch
 :
 : MS402
 - P2: 1.1
 (2), : 1.1
 : 50 Hz
 : 3 x 380-400-415
 : 3.25-3.40-3.65 A
 : 480-480-470 %
 Cos - : 0.76-0.72-0.65
 : 2850-2860-2870 /
 :
 (IEC 34-5): IP68
 (IEC 85): B
 :
 : 79192005
 :
 : MEI : 0.70
 ErP : EuP /
 : 17.9
 : 19.3
 : 0.016 ³
 Danish VVS No.: 388461008
 Finnish LVI No.: 4762682
 C : DK
 : 8413702900

98699179 SP 7-8 50

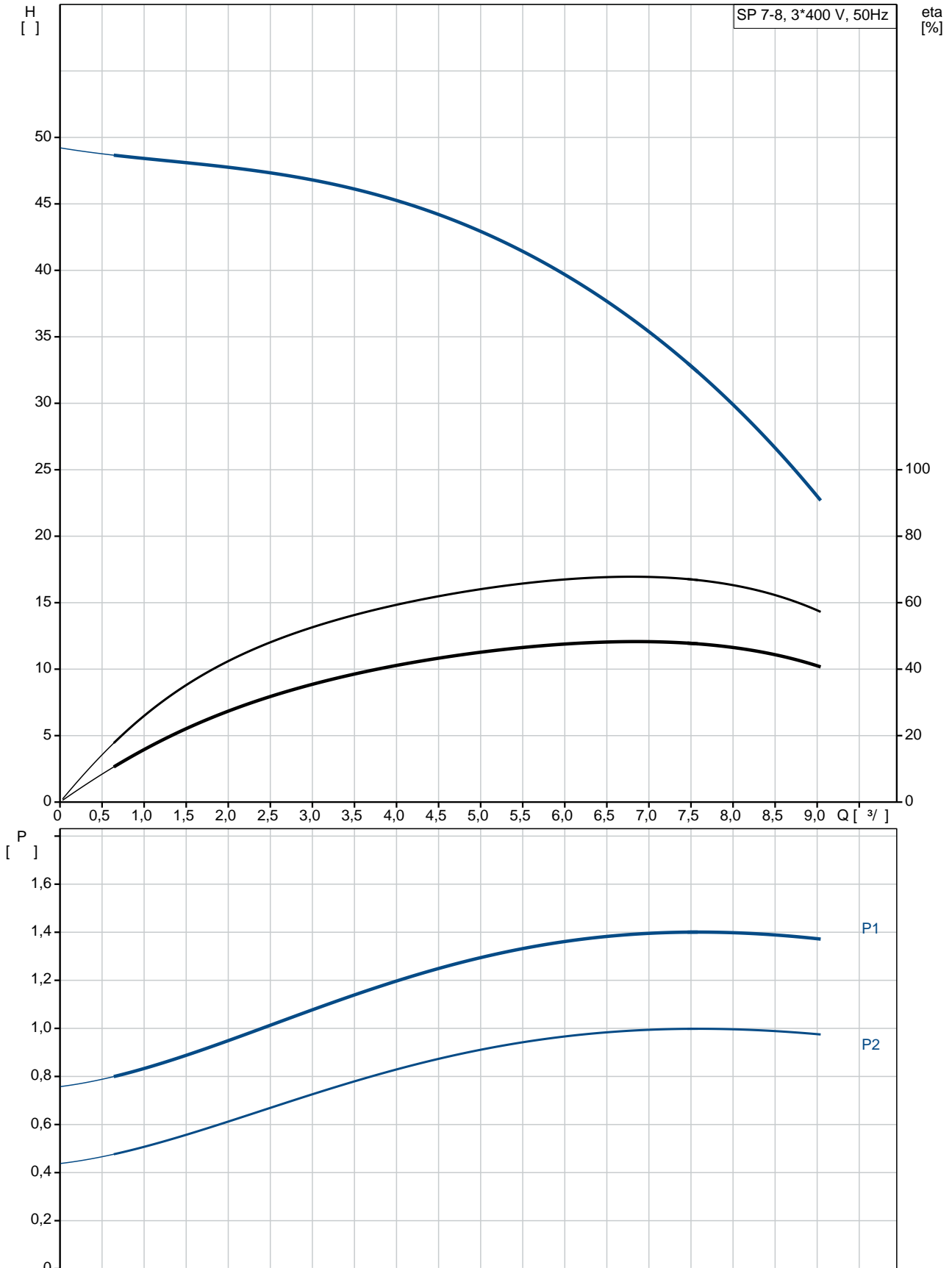

SP 7-8
 EAN : 98699179
 5712600108417

2900 /
 7 3/
 36.2
 8
 NONE
 LIPSEAL
 CE,EAC
 ISO9906:2012 3B
 A
 YES
 T40

EN 1.4301
 AISI AISI 304
 EN 1.4301
 AISI AISI 304
 DIN W.-Nr. 1.4301
 AISI 304

Rp1 1/2
 4 inch

Maximum liquid temperature: 40 °C
 . t 0,15 / : 40 °C
 20 °C
 998.2 / 3

MS402
 NEMA
 - P2: 1.1
 (2), 1.1

50 Hz
 3 x 380-400-415
 3.25-3.40-3.65 A
 480-480-470 %
 Cos - : 0.76-0.72-0.65
 2850-2860-2870 /

(IEC 34-5): IP68
 (IEC 85): B

79192005

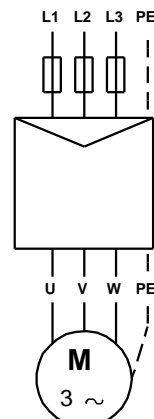
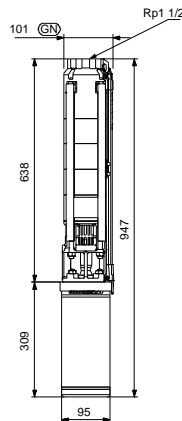
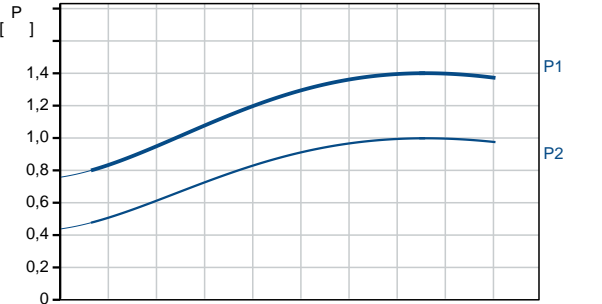
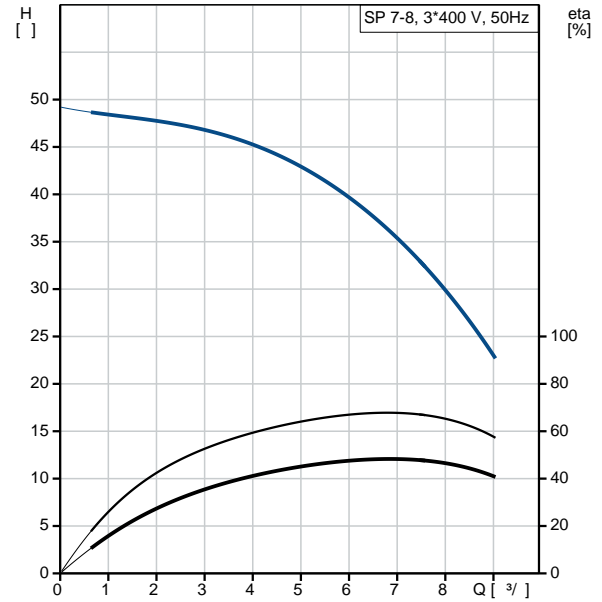

MEI :	0.70
ErP :	EuP / .
:	17.9
:	19.3
:	0.016 ³
Danish VVS No.:	388461008
Finnish LVI No.:	4762682
C :	DK
:	8413702900

98699179 SP 7-8 50

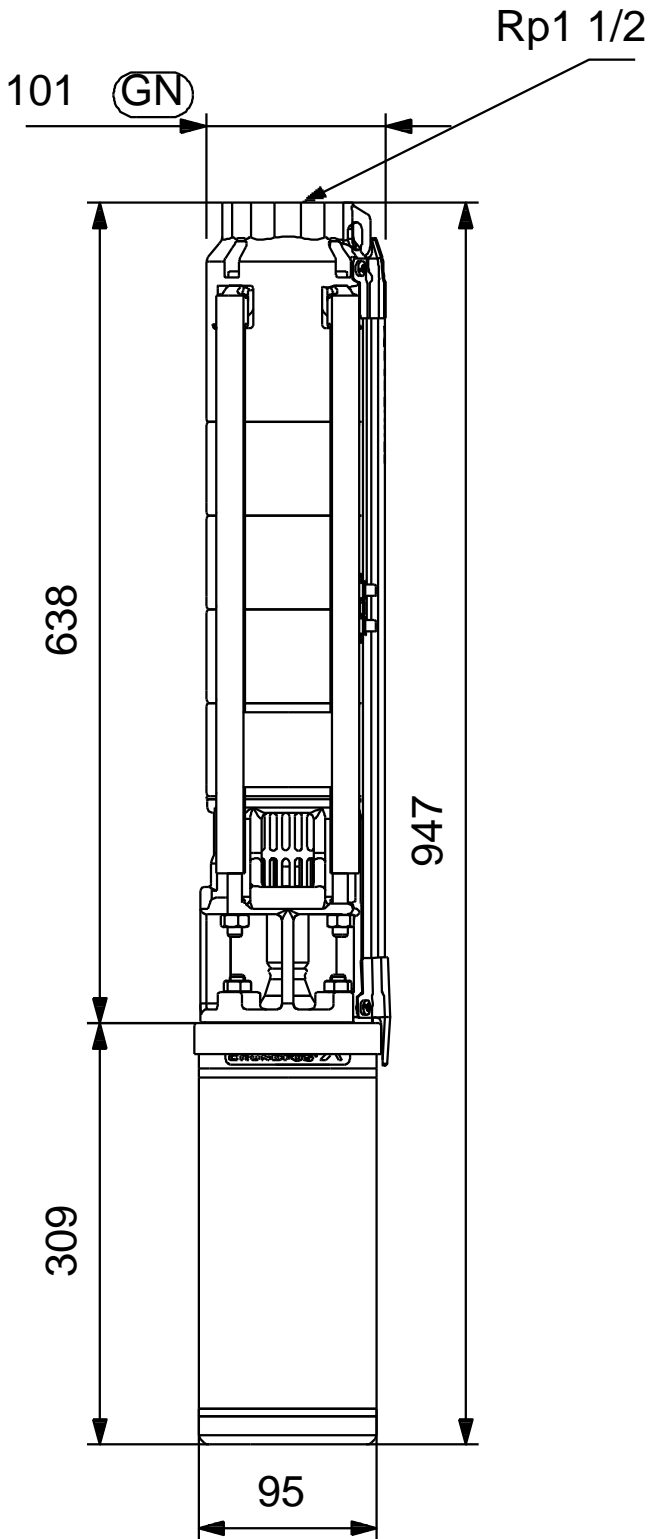

98699179 SP 7-8 50

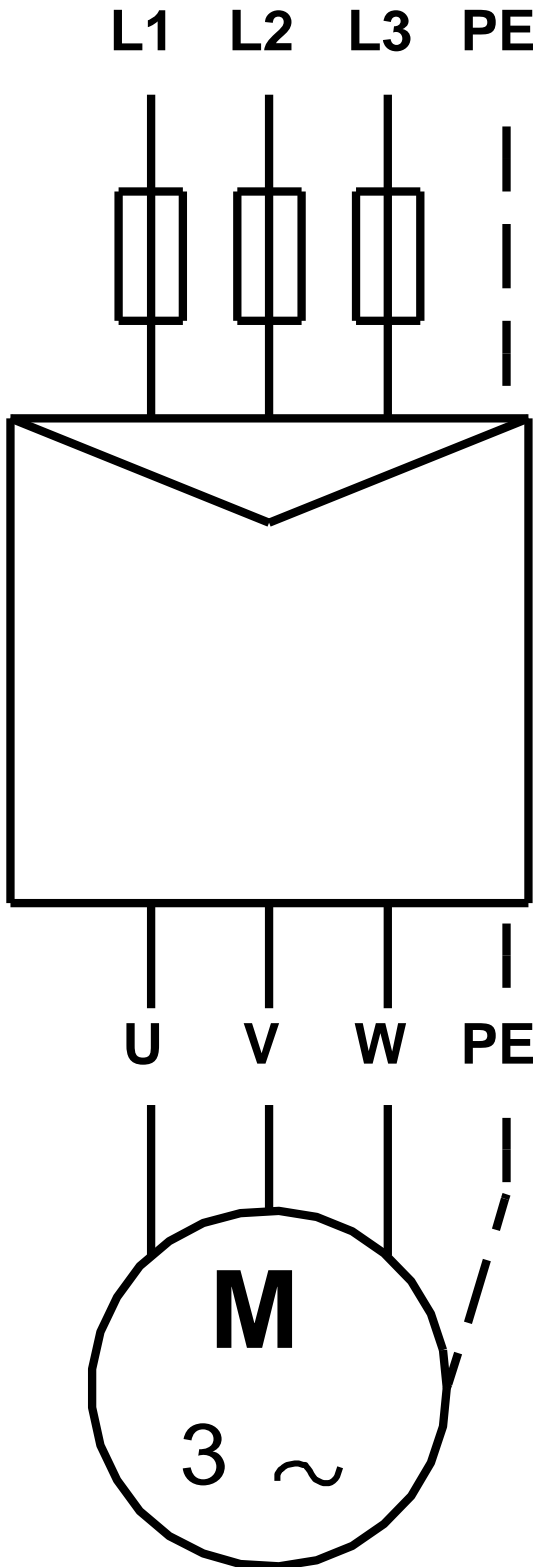

! [], .