

1 SP 9-18



: 98699058

, EN 1.4301 (AISI 304),

MS40004

40 °C.

Pt1000.
(DOL).

Maximum liquid temperature: 40 °C
 . t 0,15 / : 40 °C
 : : 20 °C
 : 998.2 / ³

: 2900 /

: 9 ³/₄
 : 94.8
 : HM/CER
 : CE,EAC
 - : ISO9906:2012 3B
 : T40

EN 1.4301
 AISI AISI 304

EN 1.4301
 AISI AISI 304

DIN W.-Nr. 1.4301
 AISI 304

: Rp2
 : 4 inch
 :
 : MS4000
 - P2: 4
 (2), : 4
 : 50 Hz
 : 3 x 380-400-415
 : 9.75-9.60-9.80 A
 : 460-500-530 %
 Cos - : 0.85-0.80-0.77
 : 2850-2865-2875 /
 :
 (IEC 34-5): IP68
 (IEC 85): F
 :
 : 79194510
 :
 ErP : MEI : 0.70
 : EuP /
 : 36.3
 : 41.9
 : 0.068 ³
 Danish VVS No.: 388480018
 Finnish LVI No.: 4762696
 C : DK
 : 8413702900

98699058 SP 9-18 50

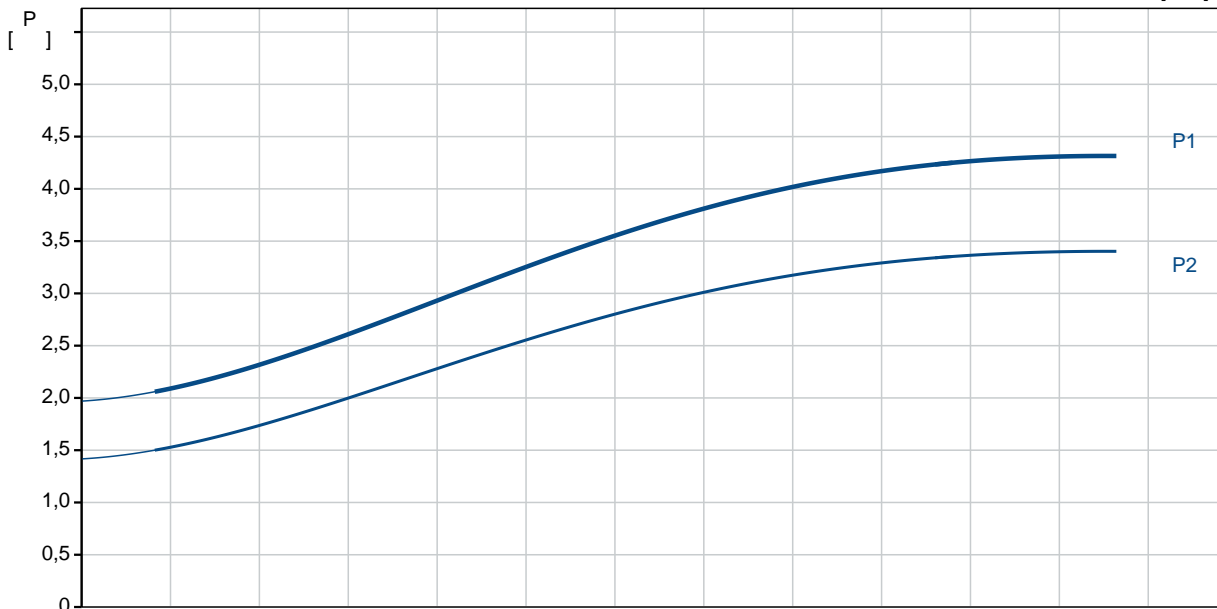
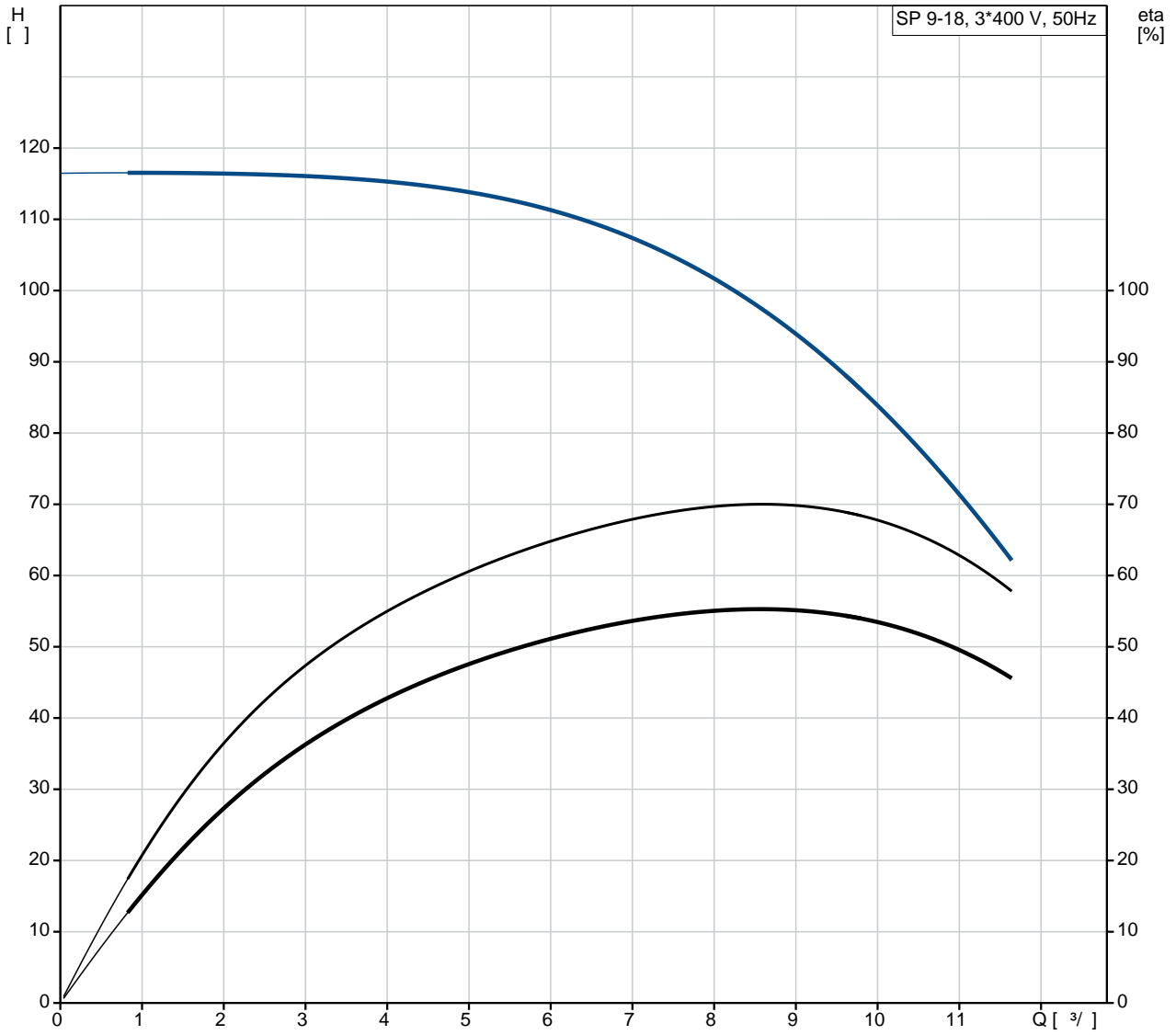

SP 9-18
 98699058
 EAN : 5712600105997
 2900 /
 9 ^{3/}
 94.8
 18
 NONE
 HM/CER
 CE,EAC
 ISO9906:2012 3B
 A
 YES
 T40

EN 1.4301
 AISI AISI 304
 EN 1.4301
 AISI AISI 304
 DIN W.-Nr. 1.4301
 AISI 304

Rp2
 4 inch

Maximum liquid temperature: 40 °C
 . t 0,15 / : 40 °C
 20 °C
 998.2 / ³

MS4000
 NEMA
 - P2: 4
 (2), 4

50 Hz
 3 x 380-400-415
 9.75-9.60-9.80 A
 460-500-530 %
 Cos - : 0.85-0.80-0.77
 2850-2865-2875 /

(IEC 34-5): IP68
 (IEC 85): F

79194510

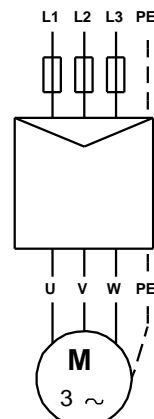
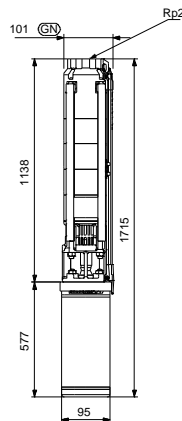
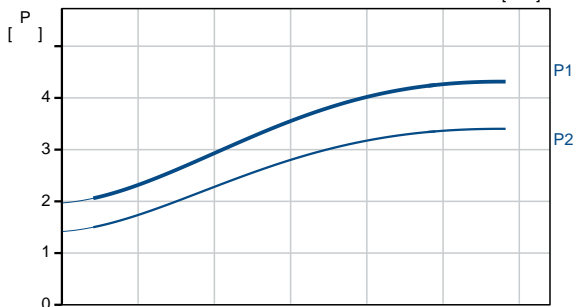
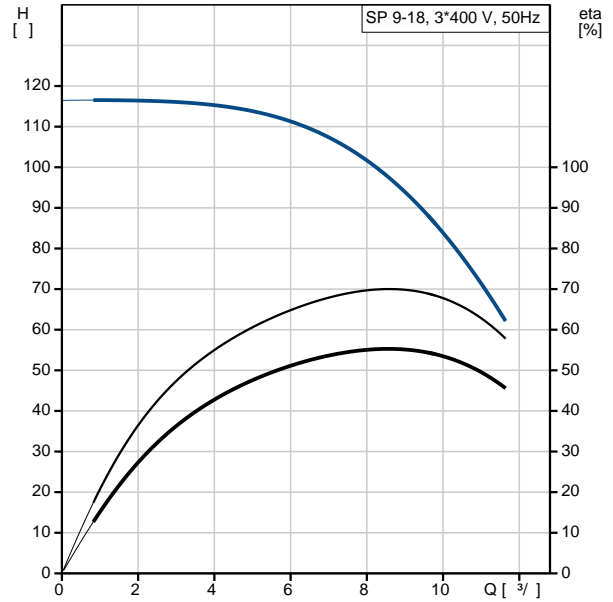

MEI :		0.70
ErP :	EuP	/ .
:		36.3
:		41.9
:		0.068 ³
Danish VVS No.:		388480018
Finnish LVI No.:		4762696
C :	DK	
:		8413702900

98699058 SP 9-18 50

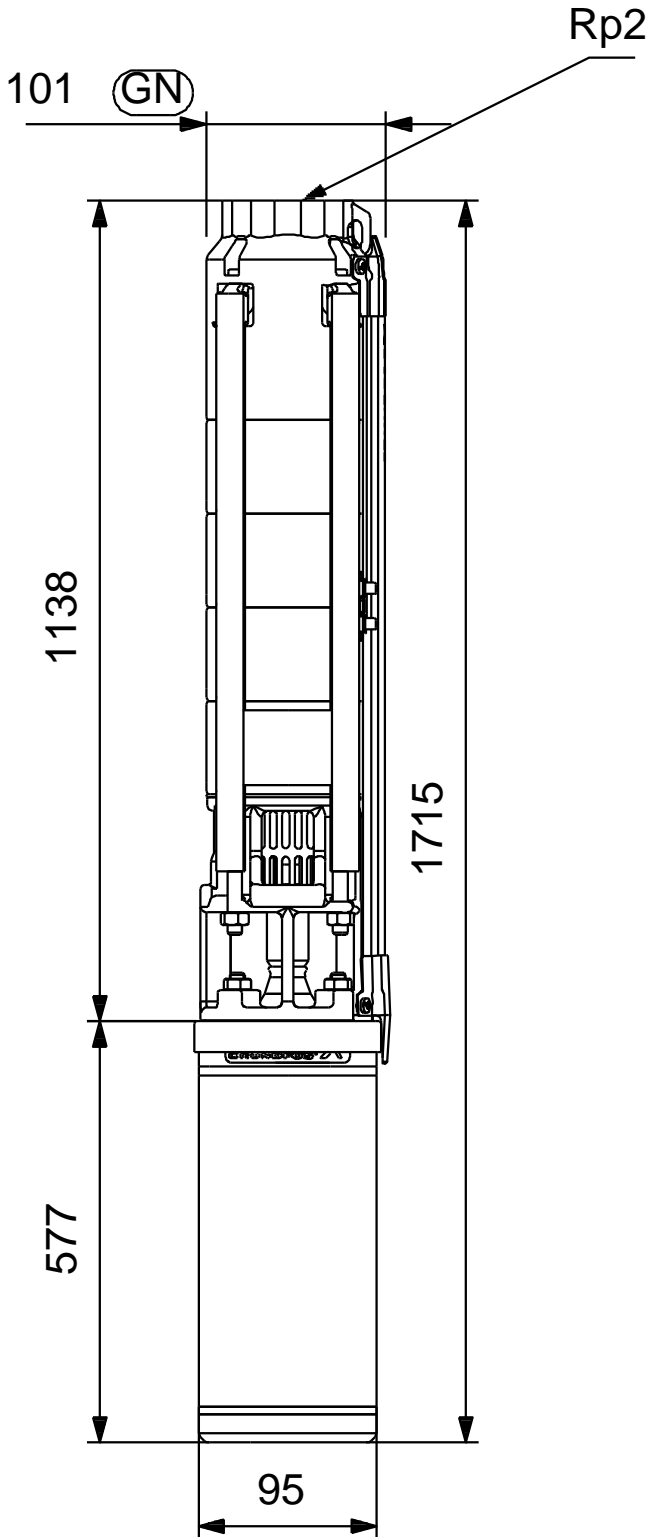

98699058 SP 9-18 50

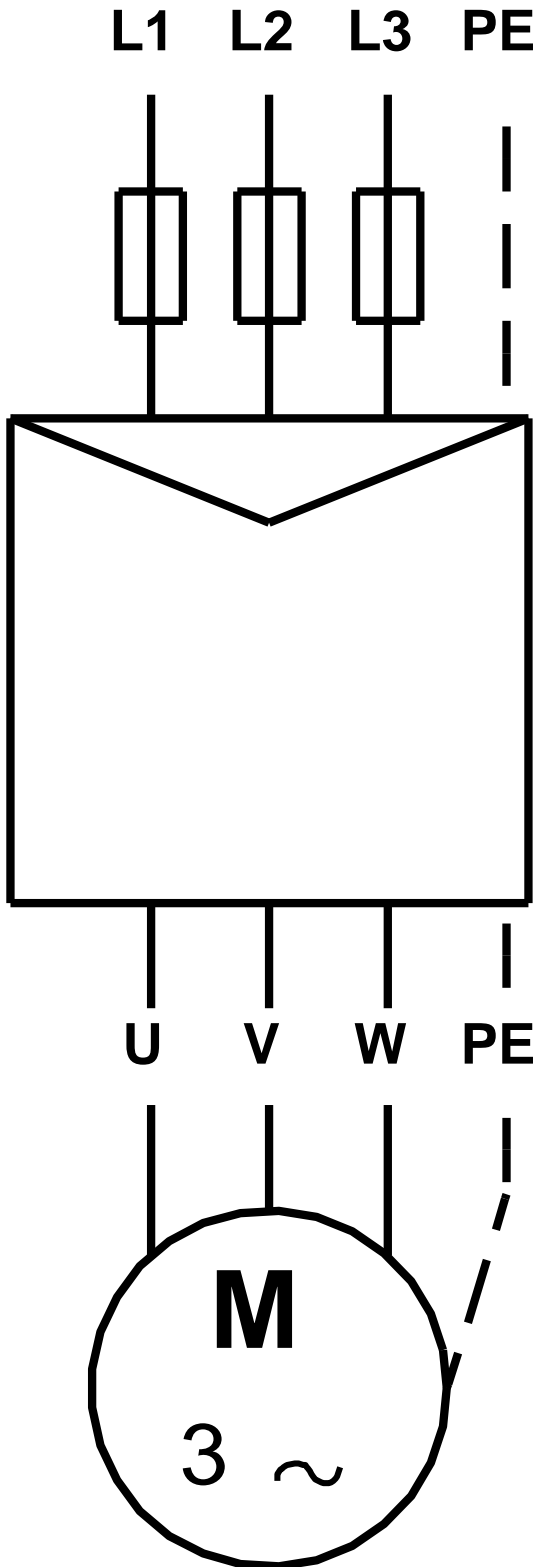

!

[],