

1 SP 9-13



: 98699056

, EN 1.4301 (AISI 304),

MS40003

40 °C.

Pt1000.
(DOL).

Maximum liquid temperature: 40 °C
 . t 0,15 / : 40 °C
 : : 20 °C
 : 998.2 / ³

: 2900 /

: 9 ³/
 : 68.2
 : HM/CER
 : CE,EAC
 - : ISO9906:2012 3B
 : T40

EN 1.4301
 AISI AISI 304

EN 1.4301
 AISI AISI 304

DIN W.-Nr. 1.4301
 AISI 304

: Rp2
 : 4 inch
 :
 : MS4000
 - P2: 3
 (2), : 3
 : 50 Hz
 : 3 x 380-400-415
 : 7.70-7.85-8.10 A
 : 460-490-500 %
 Cos - : 0.82-0.77-0.73
 : 2850-2865-2875 /
 :
 (IEC 34-5): IP68
 (IEC 85): F
 :
 : 79194508
 :
 : MEI : 0.70
 ErP : EuP /
 : 29.4
 : 31.4
 : 0.021 ³
 Danish VVS No.: 388480013
 Finnish LVI No.: 4762694
 C : DK
 : 8413702900

98699056 SP 9-13 50

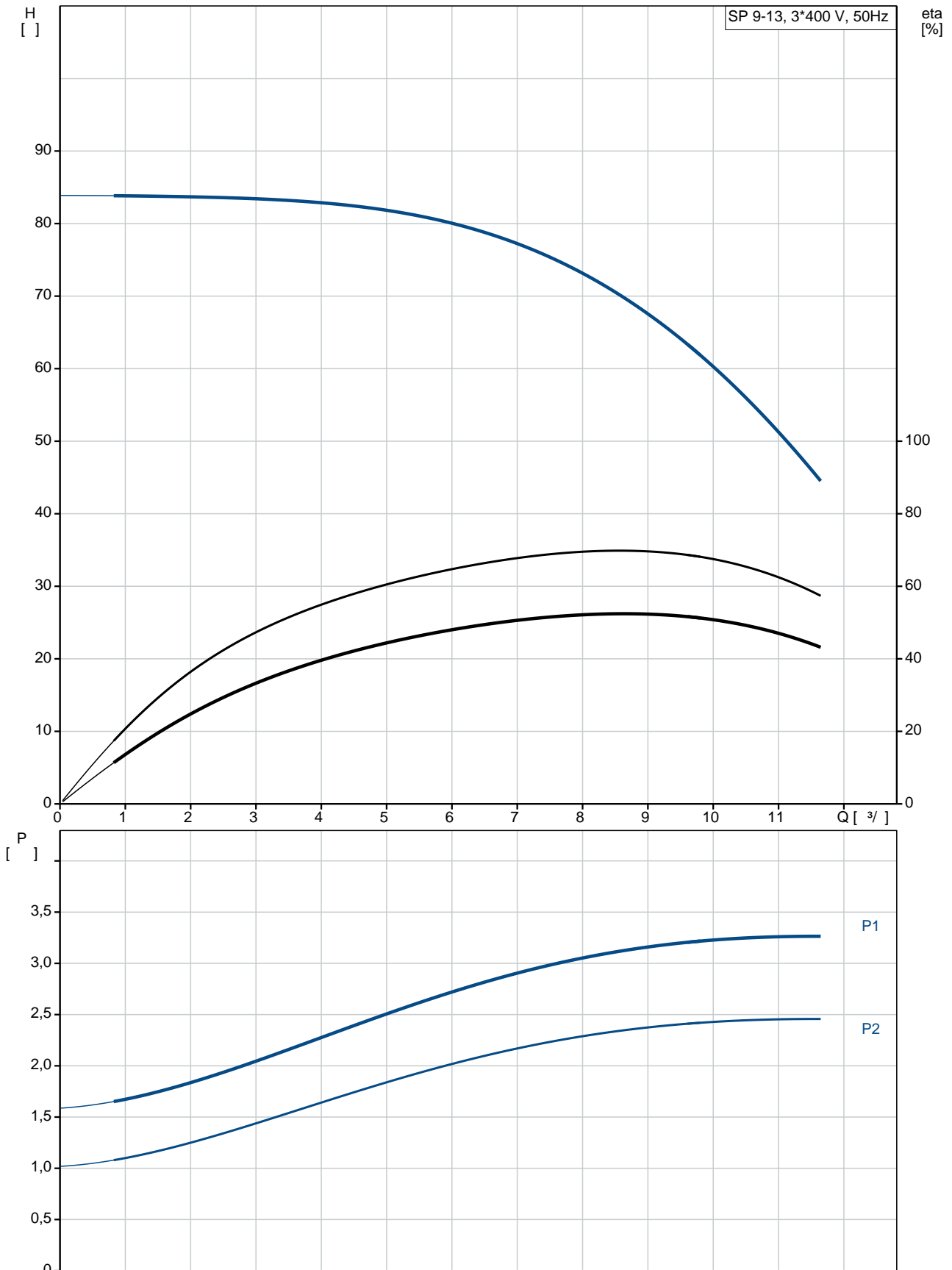

SP 9-13
 EAN : 98699056
 5712600105959

2900 /
 9 3/
 68.2
 13
 NONE
 HM/CER
 CE,EAC
 ISO9906:2012 3B
 A
 YES
 T40

EN 1.4301
 AISI AISI 304
 EN 1.4301
 AISI AISI 304
 DIN W.-Nr. 1.4301
 AISI 304

Rp2
 4 inch

Maximum liquid temperature: 40 °C
 . t 0,15 / : 40 °C
 20 °C
 998.2 / 3

MS4000
 NEMA
 - P2: 3
 (2), 3

50 Hz
 3 x 380-400-415
 7.70-7.85-8.10 A
 460-490-500 %
 Cos - : 0.82-0.77-0.73
 2850-2865-2875 /

(IEC 34-5): IP68
 (IEC 85): F

79194508

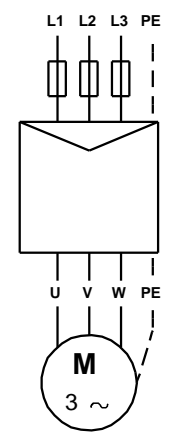
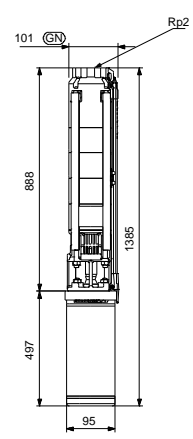
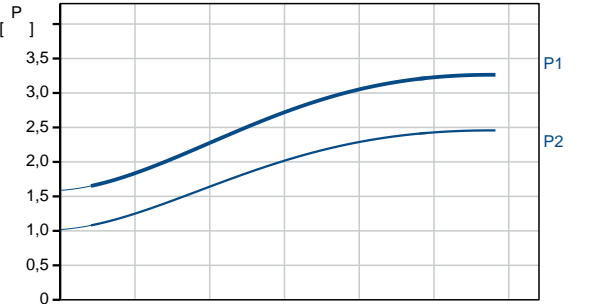
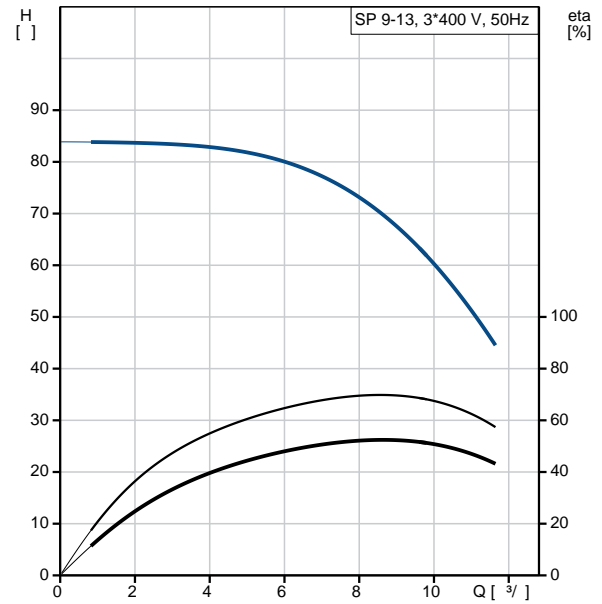

MEI :	0.70
ErP :	EuP / .
:	29.4
:	31.4
:	0.021 ³
Danish VVS No.:	388480013
Finnish LVI No.:	4762694
C :	DK
:	8413702900

98699056 SP 9-13 50

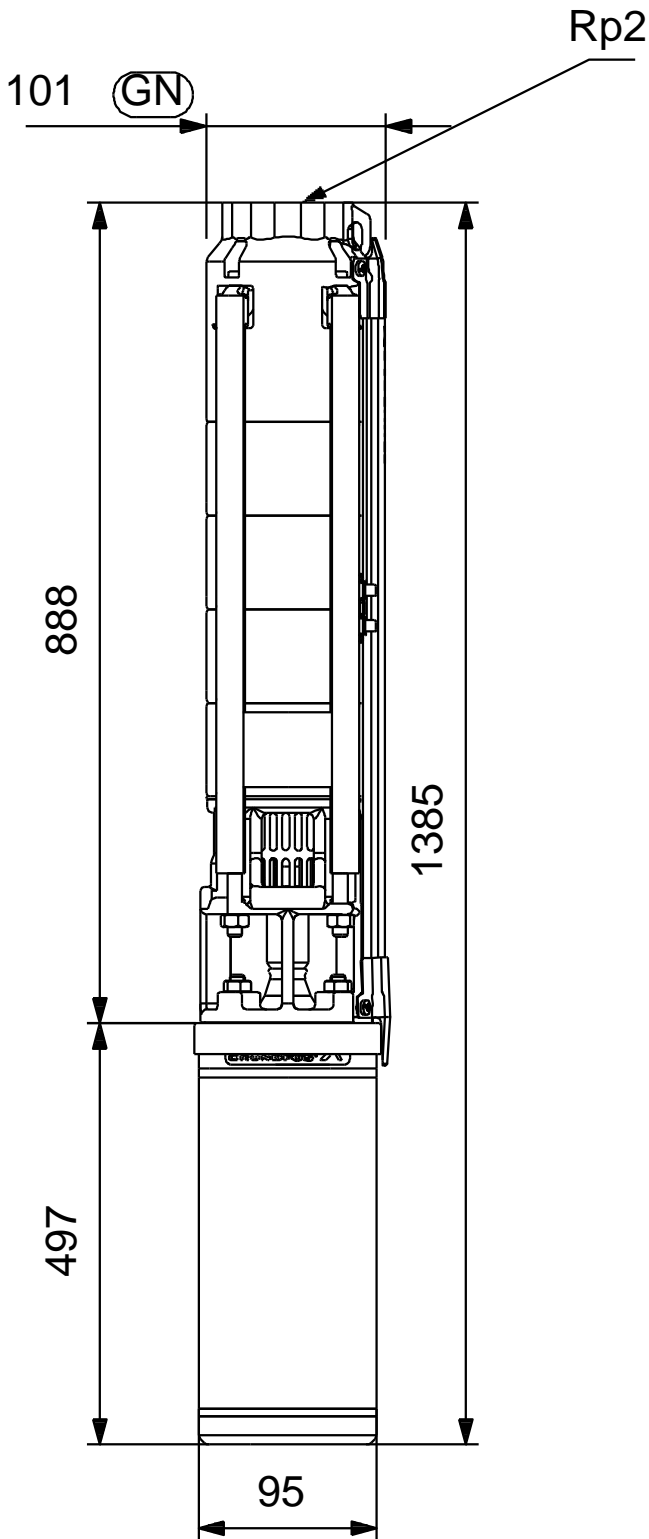

98699056 SP 9-13 50

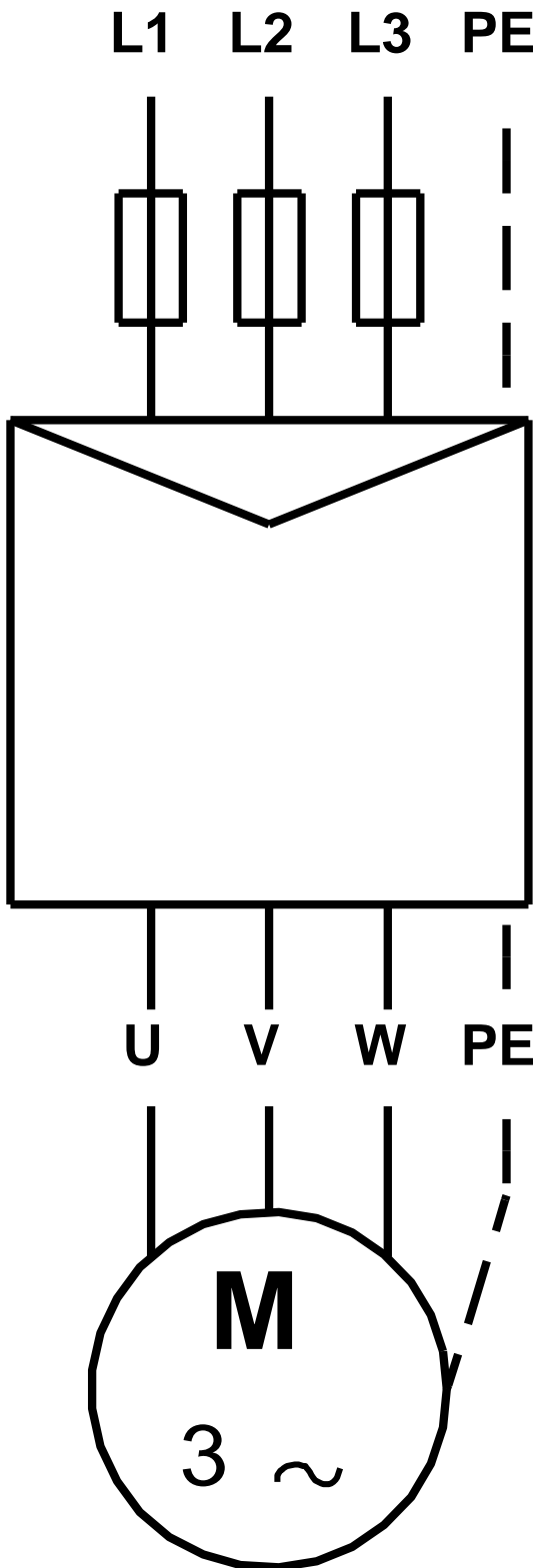

!

[],