

1 SP 9-8



: 98699054

, EN 1.4301 (AISI 304),

MS4021.5

40 °C.

Pt1000.
(DOL).

Maximum liquid temperature: 40 °C
 .t 0,15 / : 40 °C
 : 998.2 / ³ : 20 °C

: 2900 /

: 9 ³/₄
 : 41.5
 : LIPSEAL
 : CE,EAC
 - : ISO9906:2012 3B
 : T40

EN 1.4301
 AISI AISI 304

EN 1.4301
 AISI AISI 304

DIN W.-Nr. 1.4301
 AISI 304

: Rp2
 : 4 inch
 :
 : MS402
 - P2: 1.5
 (2), : 1.5
 : 50 Hz
 : 3 x 380-400-415
 : 4.10-4.20-4.40 A
 : 490-500-500 %
 Cos - : 0.80-0.75-0.70
 : 2850-2860-2870 /
 :
 (IEC 34-5): IP68
 (IEC 85): B
 :
 : 79192006
 :
 : MEI : 0.70
 ErP : EuP / .
 : 19.5
 : 21.7
 : 0.016 ³
 Danish VVS No.: 388480008
 Finnish LVI No.: 4762691
 C : DK
 : 8413702900

98699054 SP 9-8 50

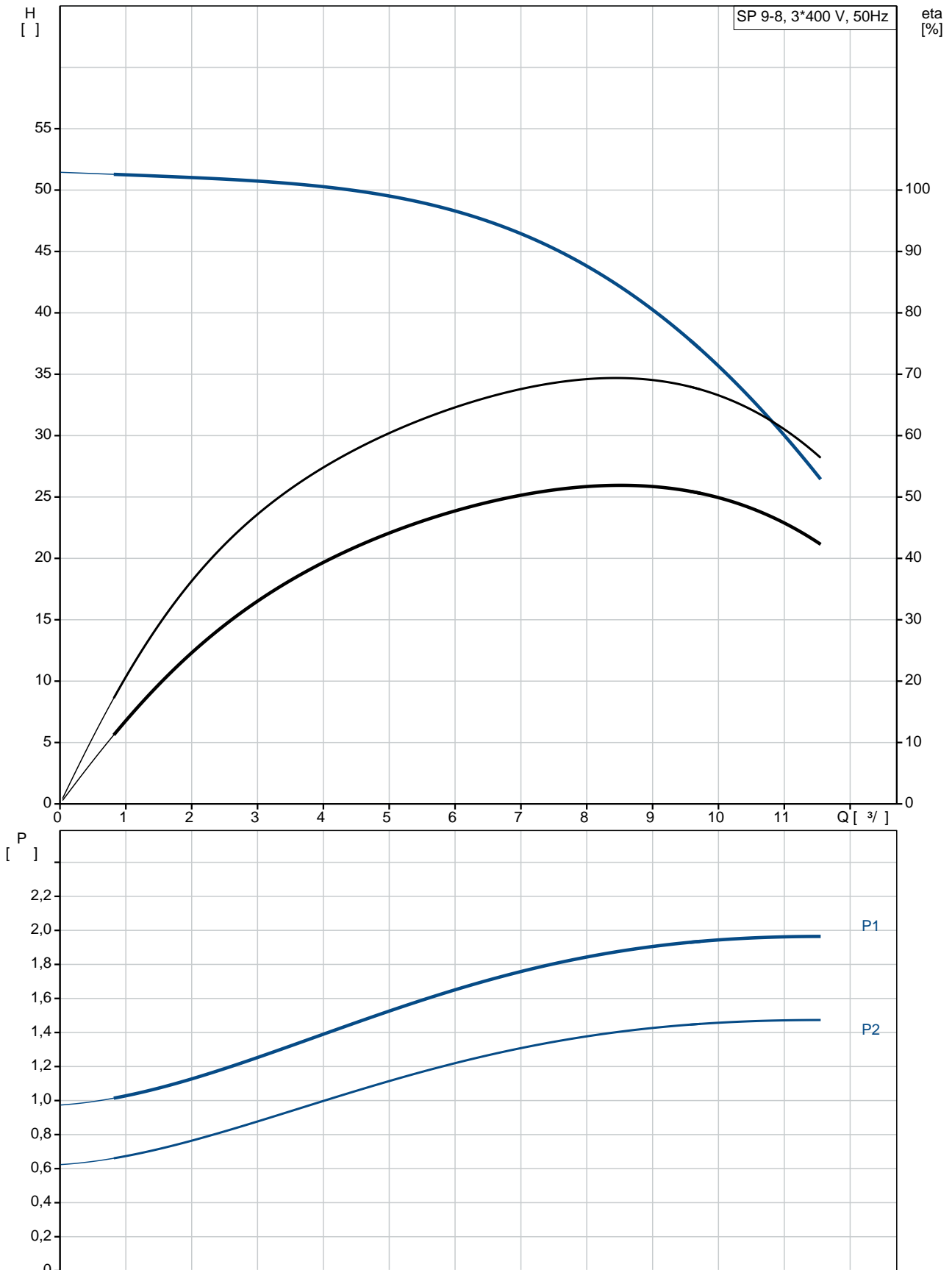

SP 9-8
 EAN : 98699054
 5712600105911

2900 /
 9 3/
 41.5
 8
 NONE
 LIPSEAL
 CE,EAC
 ISO9906:2012 3B
 A
 YES
 T40

EN 1.4301
 AISI AISI 304
 EN 1.4301
 AISI AISI 304
 DIN W.-Nr. 1.4301
 AISI 304

Rp2
 4 inch

Maximum liquid temperature: 40 °C
 . t 0,15 / : 40 °C
 20 °C
 998.2 / 3

MS402
 NEMA
 - P2: 1.5
 (2), 1.5

50 Hz
 3 x 380-400-415
 4.10-4.20-4.40 A
 490-500-500 %
 Cos - : 0.80-0.75-0.70
 2850-2860-2870 /

(IEC 34-5): IP68
 (IEC 85): B

79192006

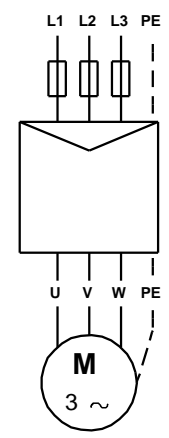
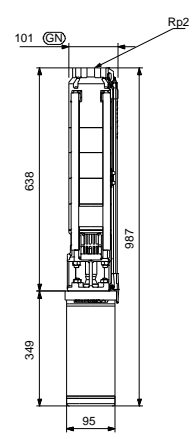
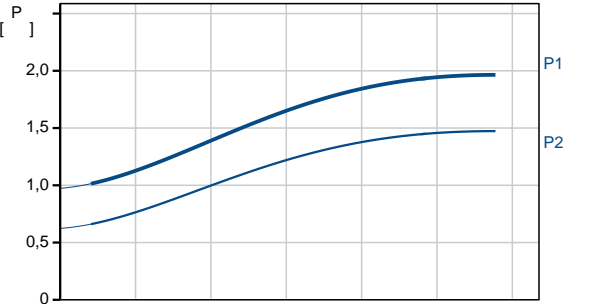
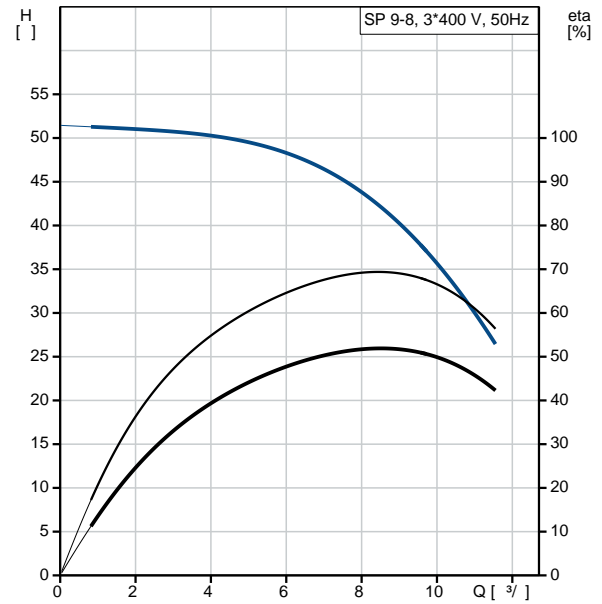

MEI :		0.70
ErP :	EuP	/ .
:		19.5
:		21.7
:		0.016 ³
Danish VVS No.:		388480008
Finnish LVI No.:		4762691
C :	DK	
:		8413702900

98699054 SP 9-8 50

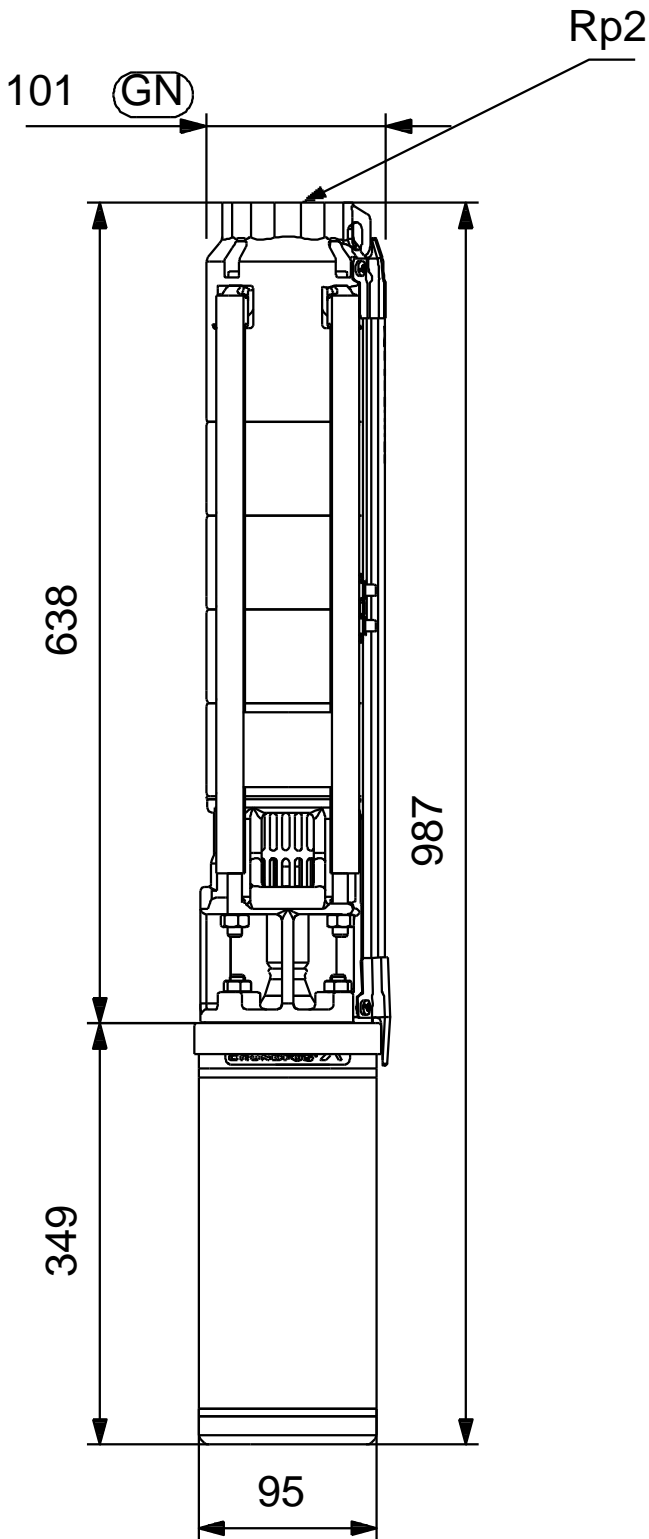

98699054 SP 9-8 50

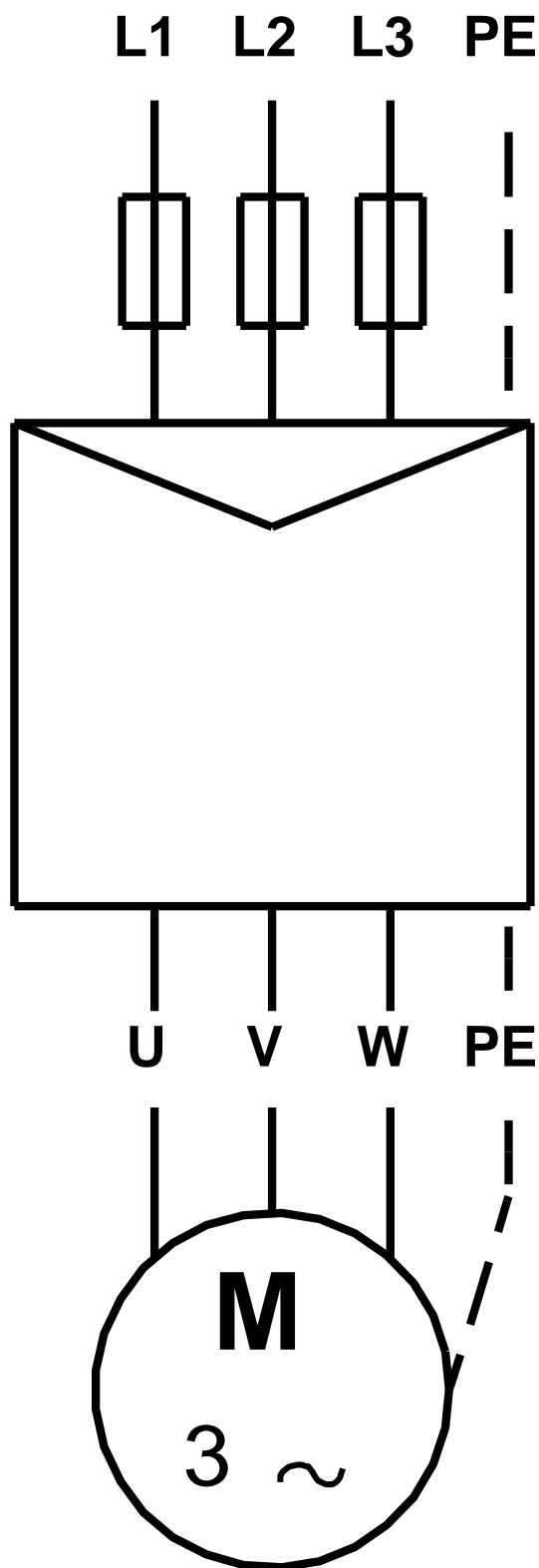

! [], .