

C : 1 x 230
1: 0.6 A
2: 0.9 A
3: 0.98 A
- : 4
(IEC 34-5): X2D
(IEC 85): F
: 14.2
: 14.8
: 0.021³
: RS
: 8413703000

95906465 UPSD 40-80 F 250 50

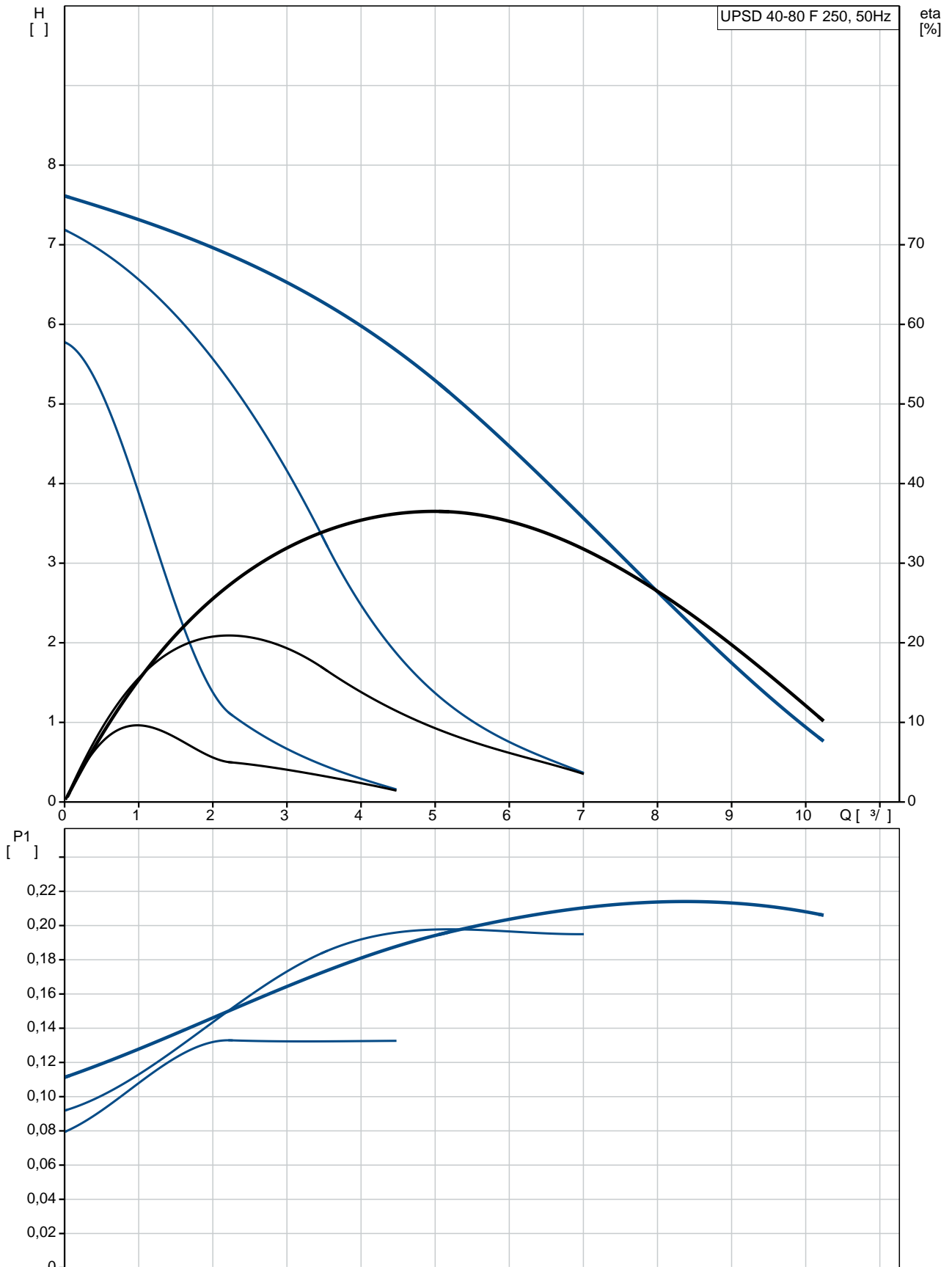

		UPSD 40-80 F 250
		95906465
EAN		5700310459639
		3
		80
TF		110
		EAC
		EN-JL1030
		ASTM 30 B
		, PES/PP
		40 °C
80 OC:		10
		DIN
		DN 40
		PN 6 / PN 10
		250
		-25 .. 110 °C
		60 °C
		983.2 / ³
		1: 135
		2: 200
		220
		50 Hz
		1 x 230
	1:	0.6 A
	2:	0.9 A
	3:	0.98 A
		4
	(IEC 34-5):	X2D
	(IEC 85):	F
		CONTACT
		12H
		14.2
		14.8
		0.021 ³
C		RS
		8413703000

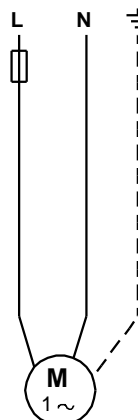
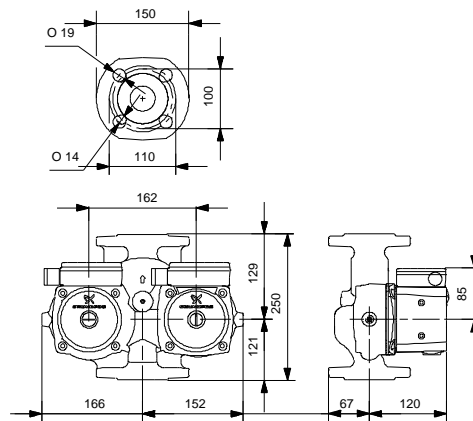
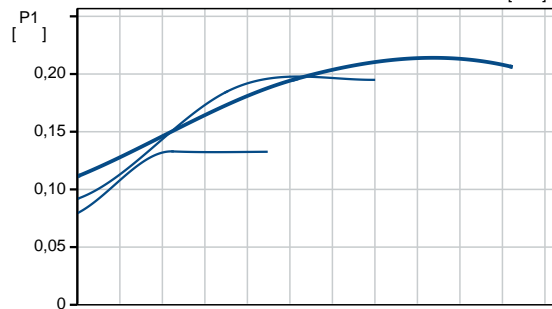
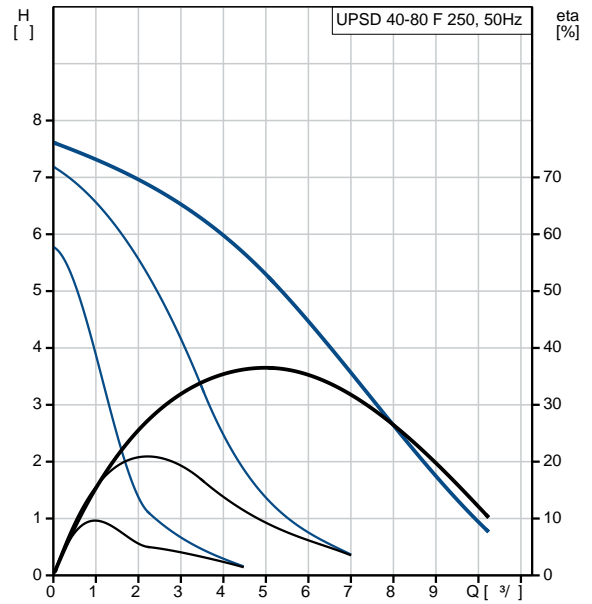

95906465 UPSD 40-80 F 250 50

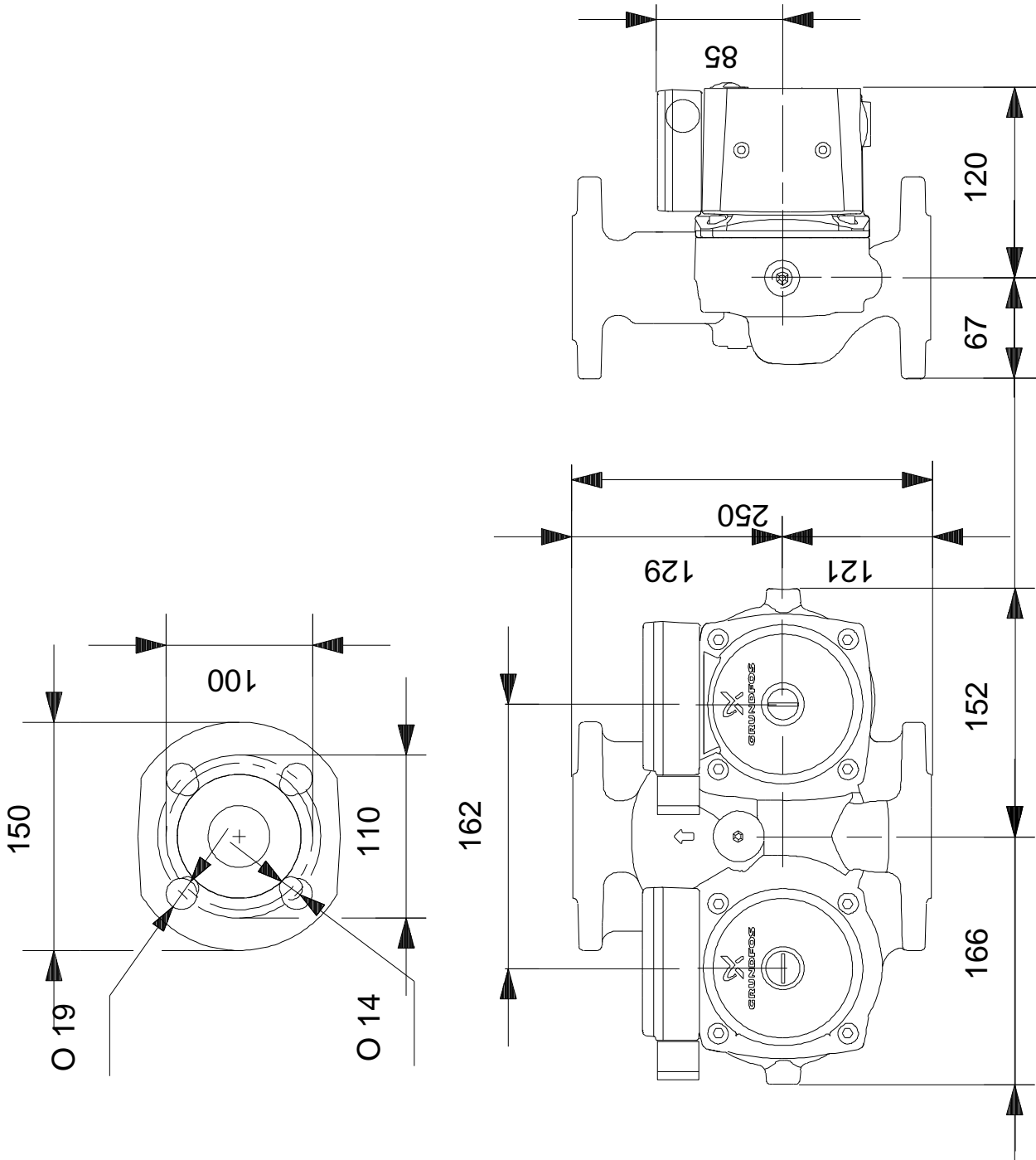

95906465 UPSD 40-80 F 250 50

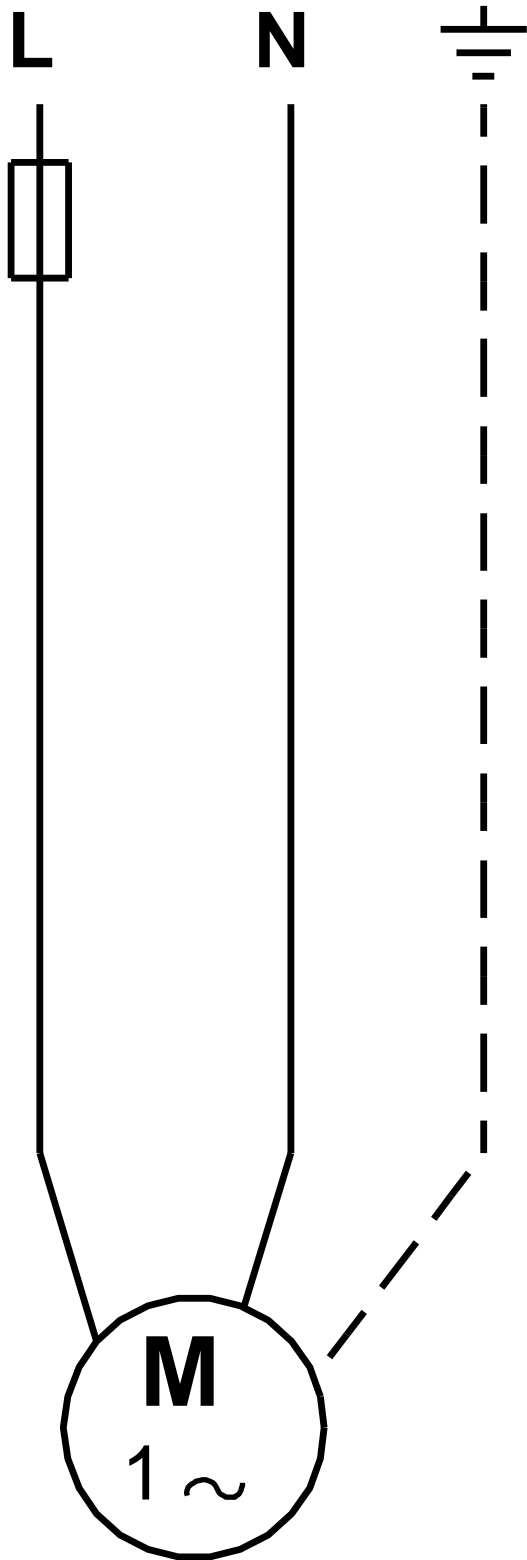

! [], .