

1 UPSD 32-80 180



: 95906455

, PES/PP.

: -25 .. 110 °C  
 : 60 °C  
 983.2 / <sup>3</sup>

TF : 110  
 : EAC

EN-JL1030  
 ASTM 30 B  
 , PES/PP

.T : - 80 0C: 40 °C

10  
 G 2  
 PN 10  
 180

1: 135  
 2: 200

: 220  
 : 50 Hz  
 : 1 x 230

1: 0.6 A  
2: 0.9 A  
3: 0.98 A  
- : 4  
(IEC 34-5): X2D  
(IEC 85): F

:  
:  
:  
:  
C : 10.8  
: 11.3  
: 0.015 <sup>3</sup>  
: RS  
: 8413703000

## 95906455 UPSD 32-80 180 50

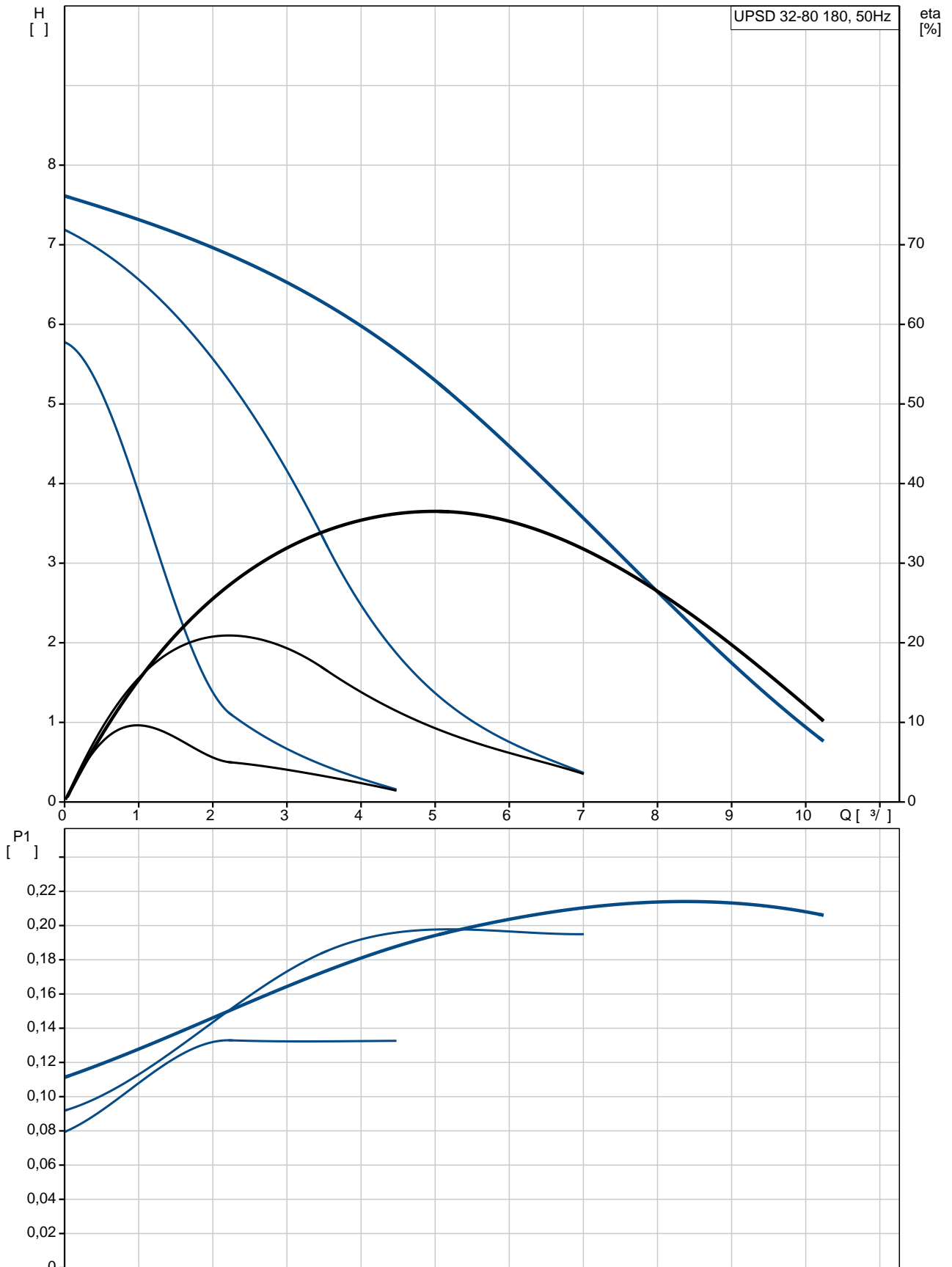

	UPSD 32-80 180
	95906455
EAN	5700310353951
	3
	80
TF	110
	EAC
	EN-JL1030
	ASTM 30 B
	, PES/PP
80 OC:	40 °C
	10
	G 2
	PN 10
	180
	-25 .. 110 °C
	60 °C
	983.2 / ³
	1: 135
	2: 200
	220
	50 Hz
	1 x 230
	1: 0.6 A
	2: 0.9 A
3:	0.98 A
	4
(IEC 34-5):	X2D
(IEC 85):	F
	CONTACT
	12H
	10.8
	11.3
	0.015 ³
C	RS
	8413703000

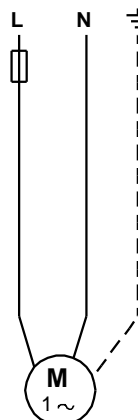
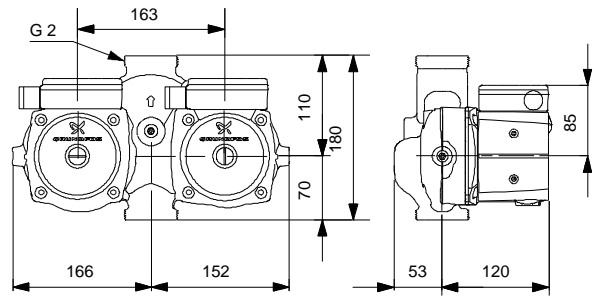
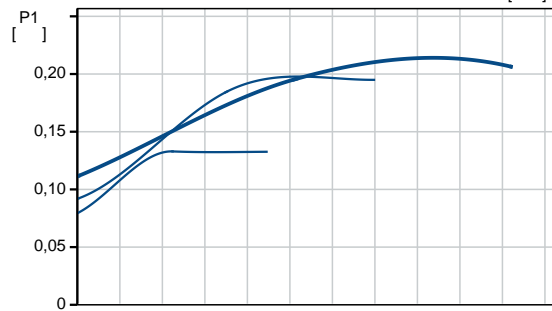
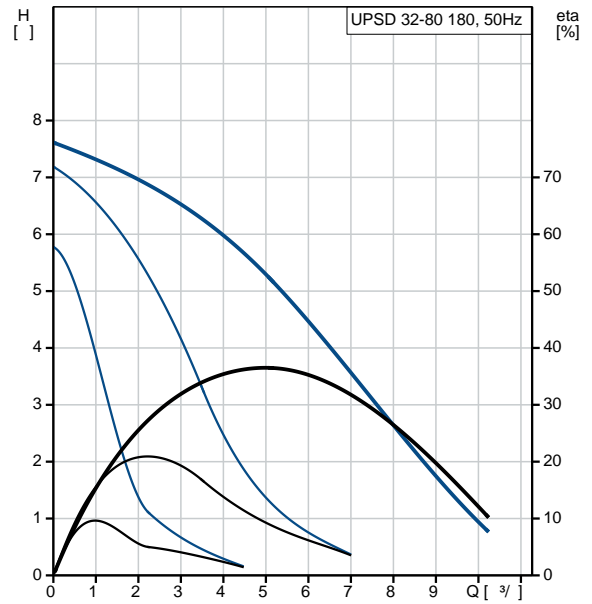

**95906455 UPSD 32-80 180 50**

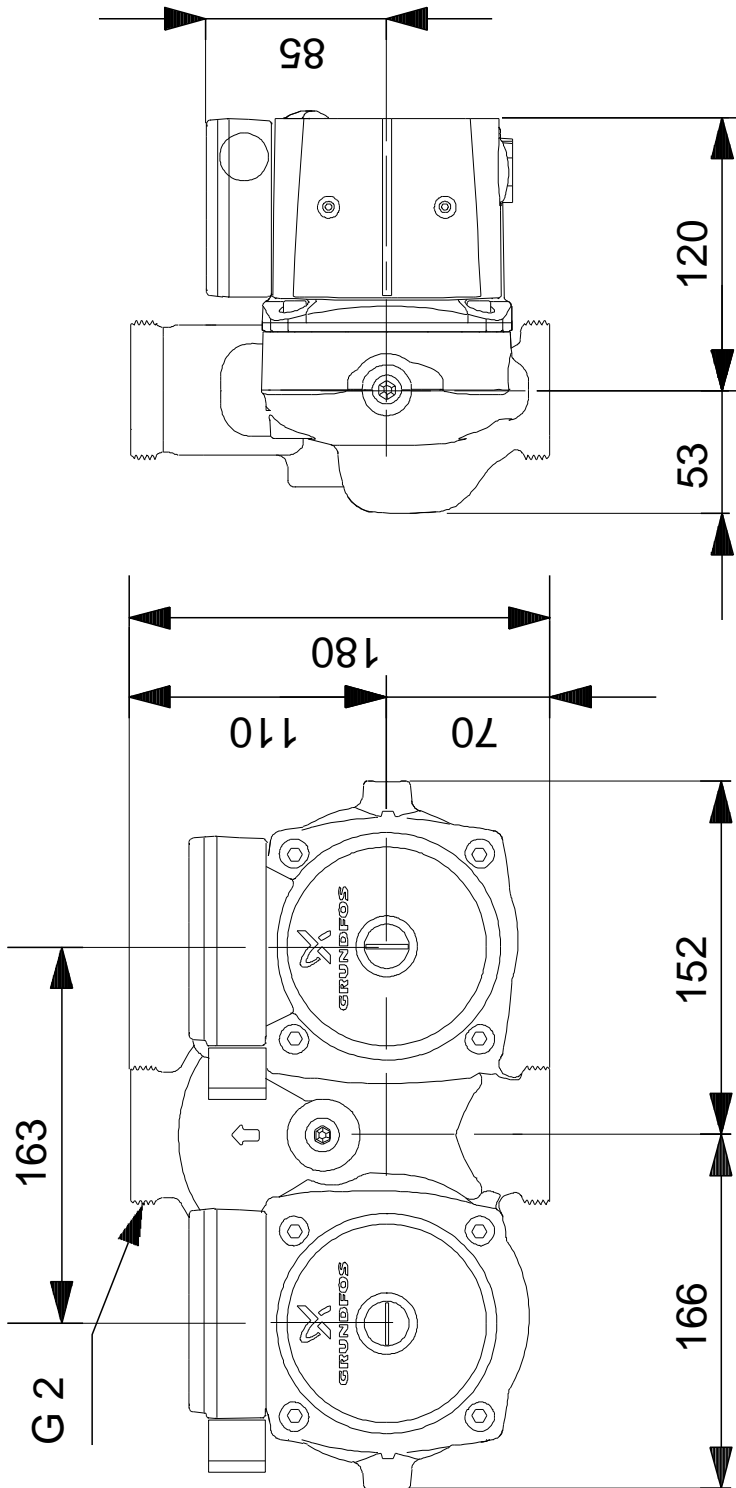

95906455 UPSD 32-80 180 50

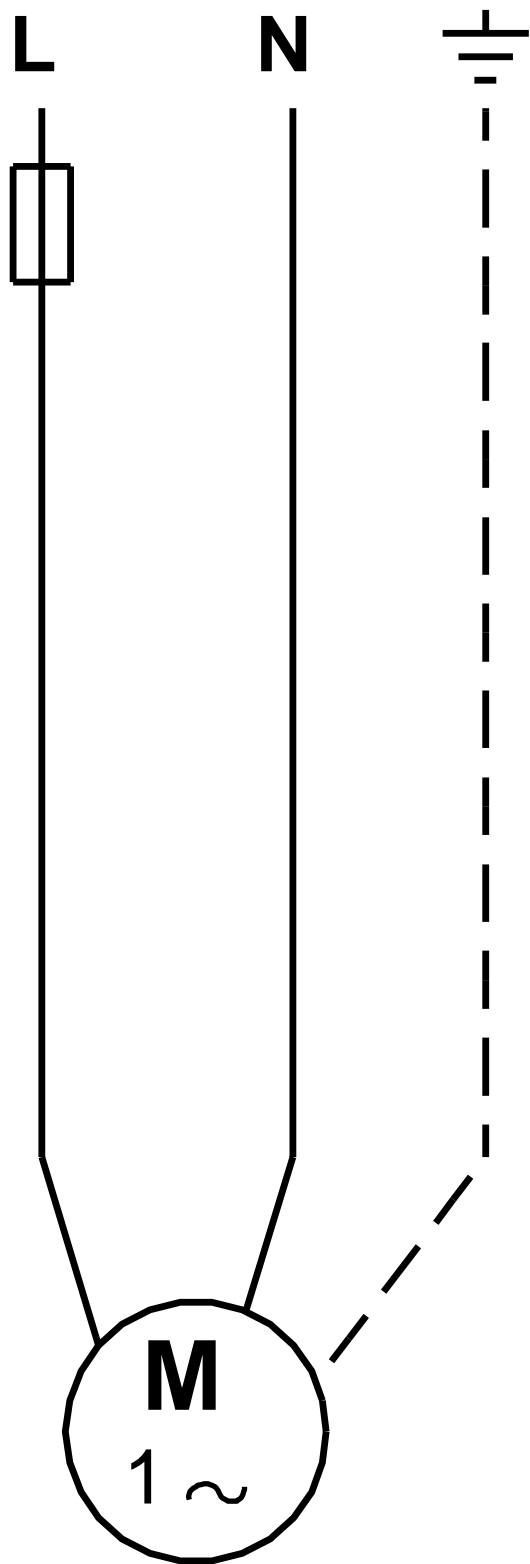

! [ ], .