

1 UPSD 40-50 F 250



: 95906423

-  
 -  
 -  
 : PES/PP.  
 1-  
 : -25 .. 110 °C  
 : 60 °C  
 : 983.2 / 3  
 TF : 110  
 : EAC  
 EN-JL1030  
 ASTM 30 B  
 , PES/PP  
 .T : - 80 0C: 40 °C  
 : 10  
 : DIN  
 : DN 40  
 : PN 10  
 : 250  
 :  
 : 1: 75  
 : 2: 100  
 : 105  
 : 50 Hz

: 1 x 230  
1: 0.32 A  
2: 0.44 A  
3: 0.46 A  
- : 2.5  
(IEC 34-5): X2D  
(IEC 85): F

C :  
: 14.1  
: 14.2  
: 0.021<sup>3</sup>  
: RS  
: 8413703000

## 95906423 UPSD 40-50 F 250 50

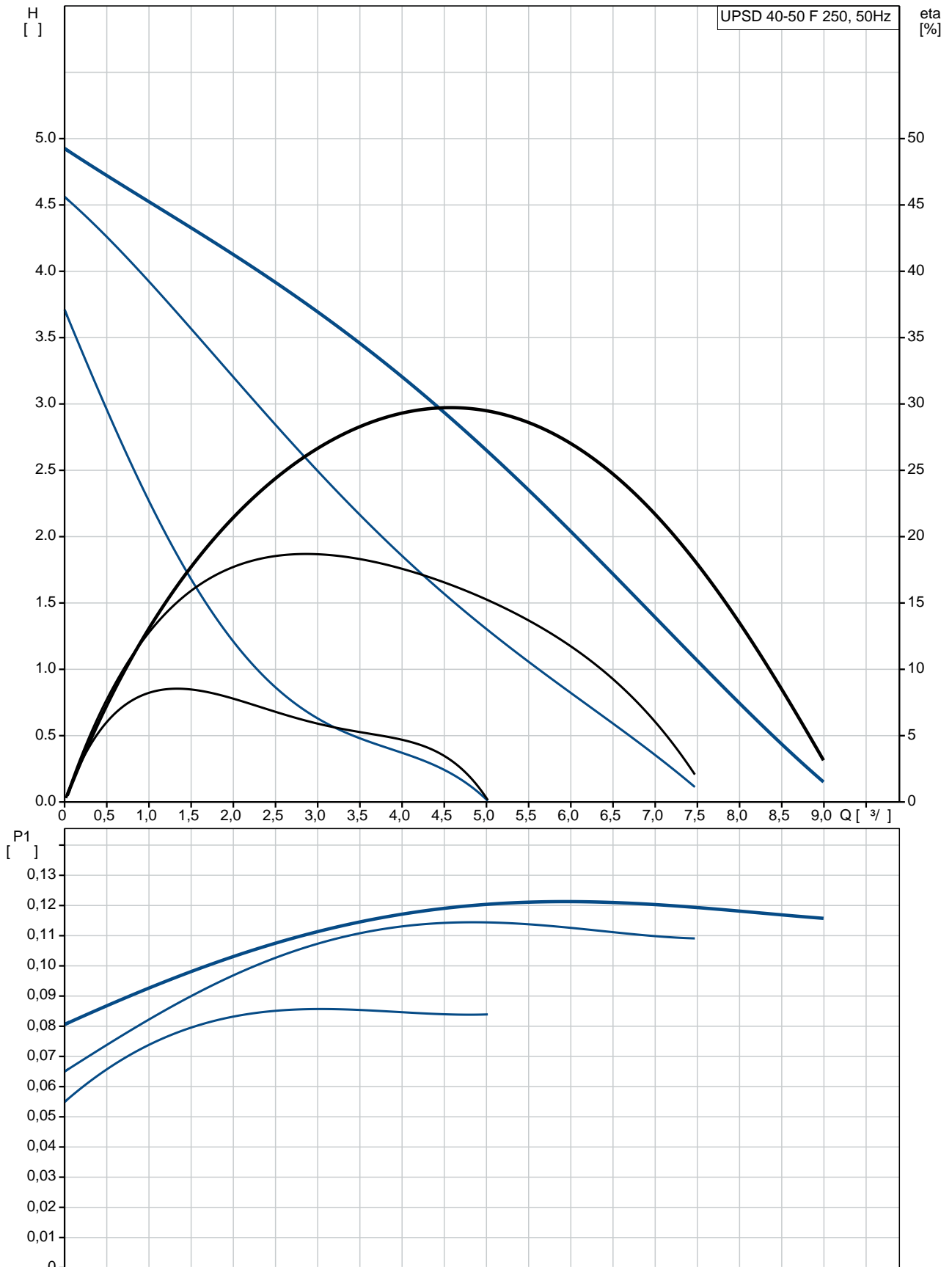

		UPSD 40-50 F 250
		<a href="#">95906423</a>
EAN		5700310311760
		3
		50
TF		110
		EAC
		EN-JL1030
		ASTM 30 B
		, PES/PP
80 OC:		40 °C
		10
		DIN
		DN 40
		PN 10
		250
		-25 .. 110 °C
		60 °C
		983.2 / 3
		1: 75
		2: 100
		105
		50 Hz
		1 x 230
	1:	0.32 A
	2:	0.44 A
	3:	0.46 A
		2.5
	(IEC 34-5):	X2D
	(IEC 85):	F
		CONTACT
		12H
		14.1
		14.2
		0.021 3
C		RS
		8413703000

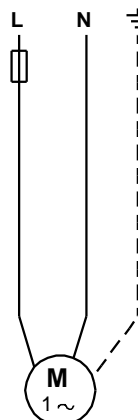
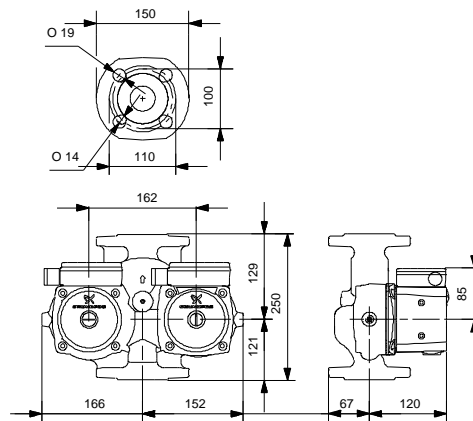
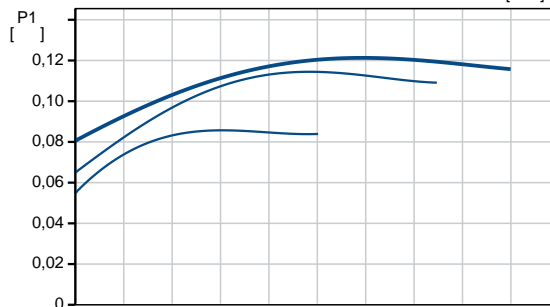
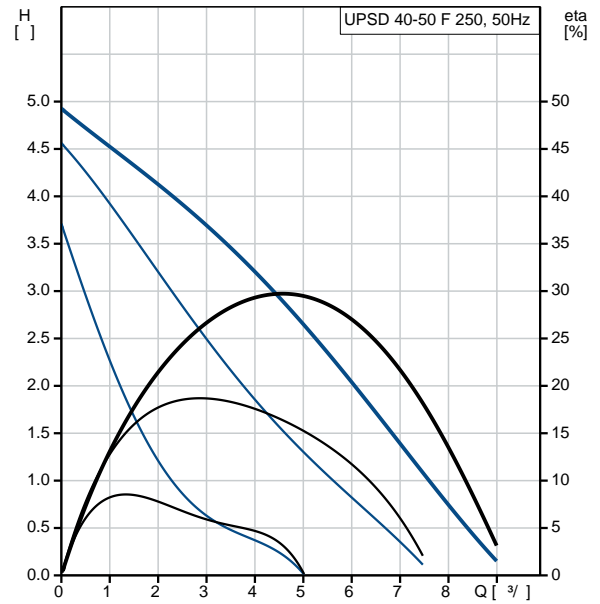

## 95906423 UPSD 40-50 F 250 50

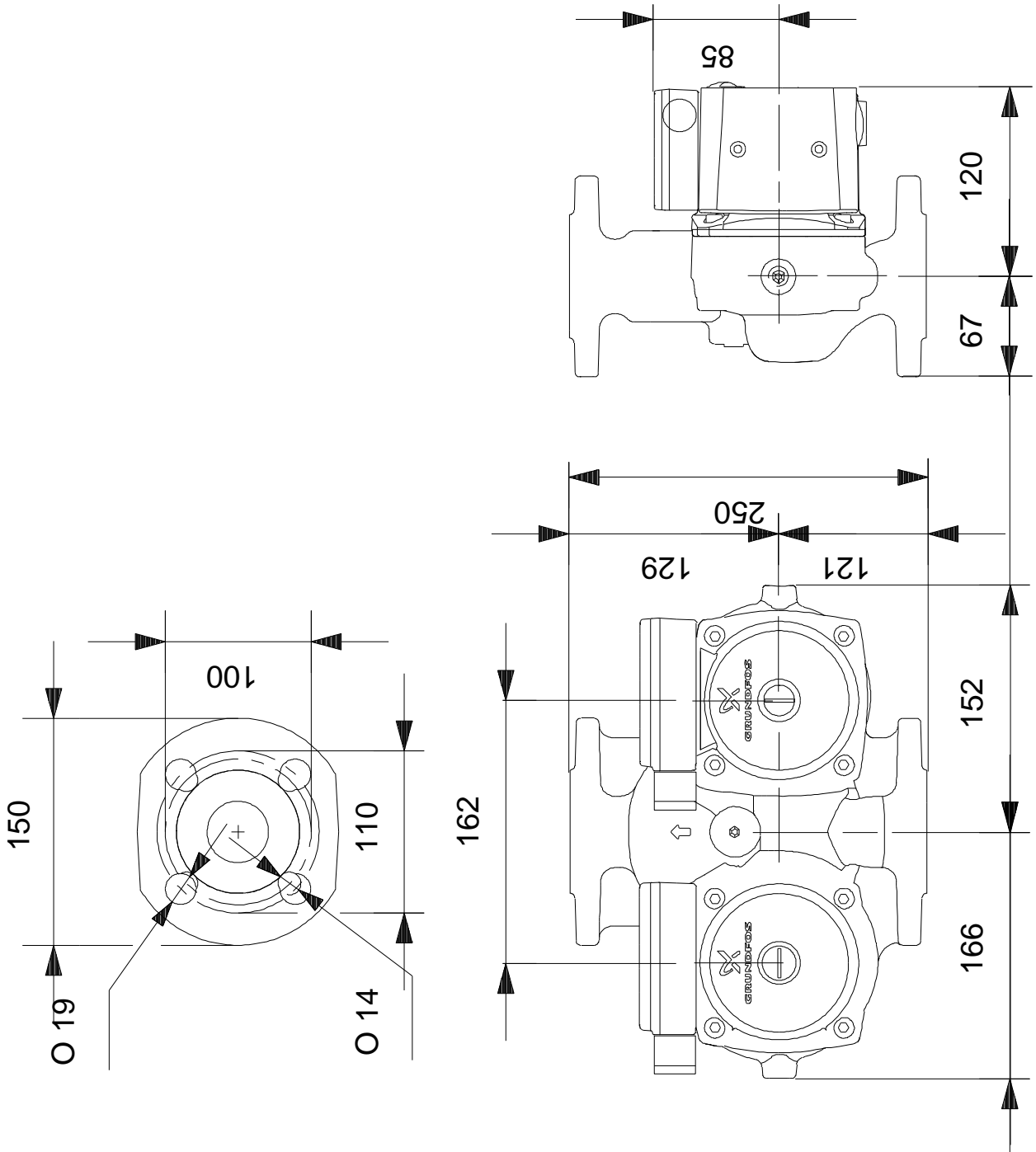

95906423 UPSD 40-50 F 250 50

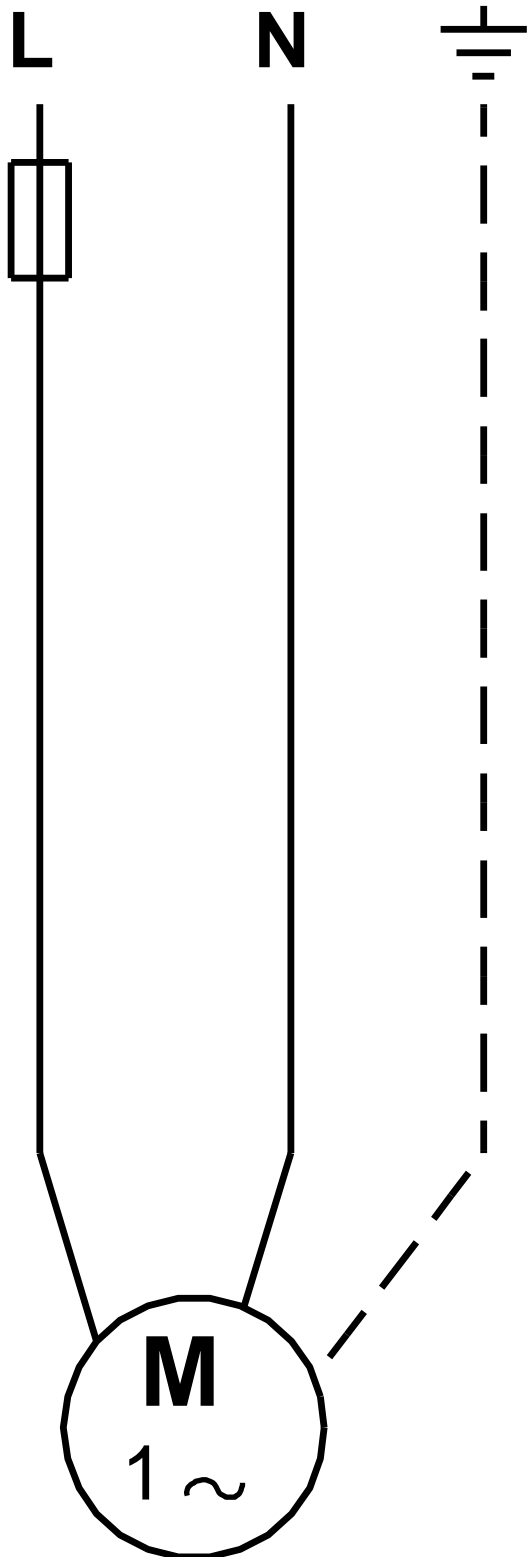

! [ ], .