

1 UPSD 32-50 180



: 95906413

-
-
-

, PES/PP.

: -25 .. 110 °C
: 60 °C
983.2 / ³

TF : 110
: AAA,EAC

EN-JL1030
ASTM 30 B
, PES/PP

.T : - 80 0C: 40 °C

10
G 2
PN 10
180

1: 75
2: 100

: 105
: 50 Hz
: 1 x 230

1: 0.32 A
2: 0.44 A
3: 0.46 A
- : 2.5
(IEC 34-5): X2D
(IEC 85): F

:
:
:
:
C : 10.7
: 11.1
: 0.018 ³
: RS
: 8413703000

95906413 UPSD 32-50 180 50

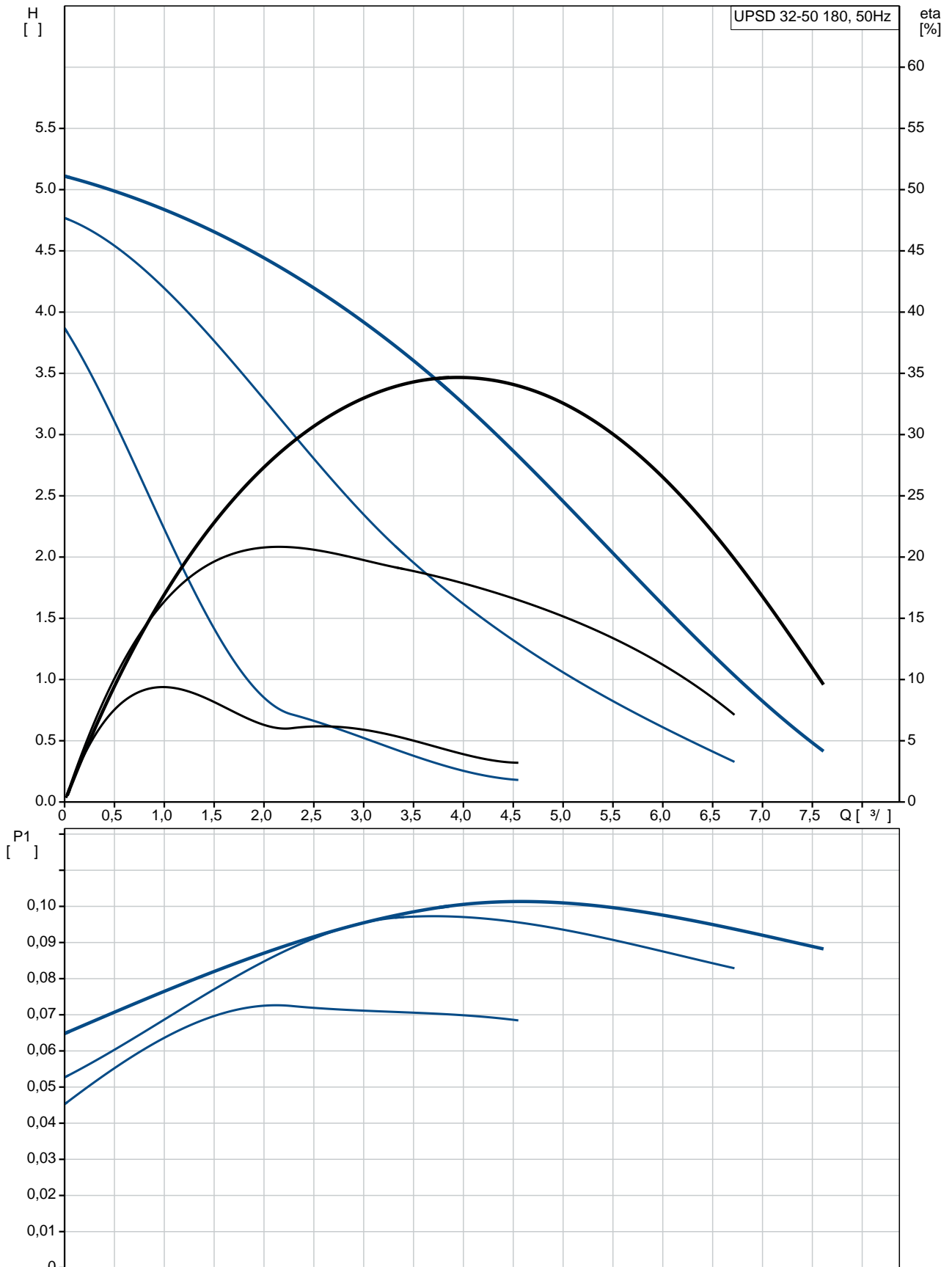

	UPSD 32-50 180
	95906413
EAN	5700310307756
	3
	50
TF	110
	AAA,EAC
	EN-JL1030
	ASTM 30 B
	, PES/PP
80 OC:	40 °C
	10
	G 2
	PN 10
	180
	-25 .. 110 °C
	60 °C
	983.2 / ³
	1: 75
	2: 100
	105
	50 Hz
	1 x 230
	1: 0.32 A
	2: 0.44 A
	3: 0.46 A
	2.5
	(IEC 34-5): X2D
	(IEC 85): F
	CONTACT
	12H
	10.7
	11.1
	0.018 ³
C	RS
	8413703000

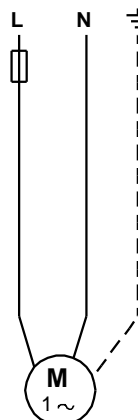
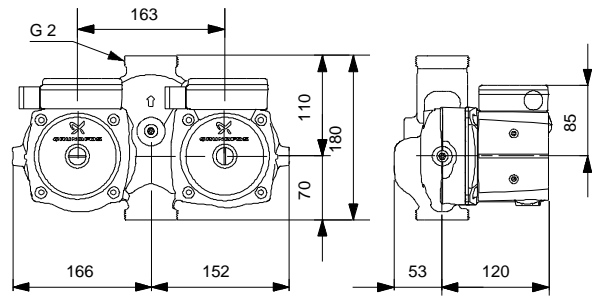
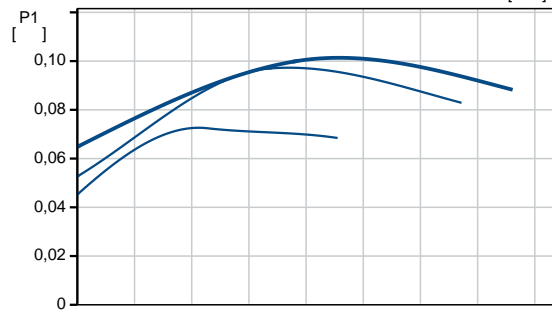
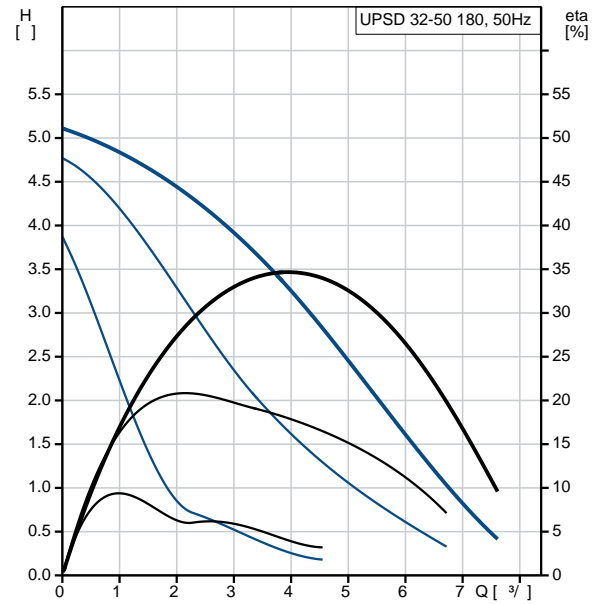

95906413 UPSD 32-50 180 50

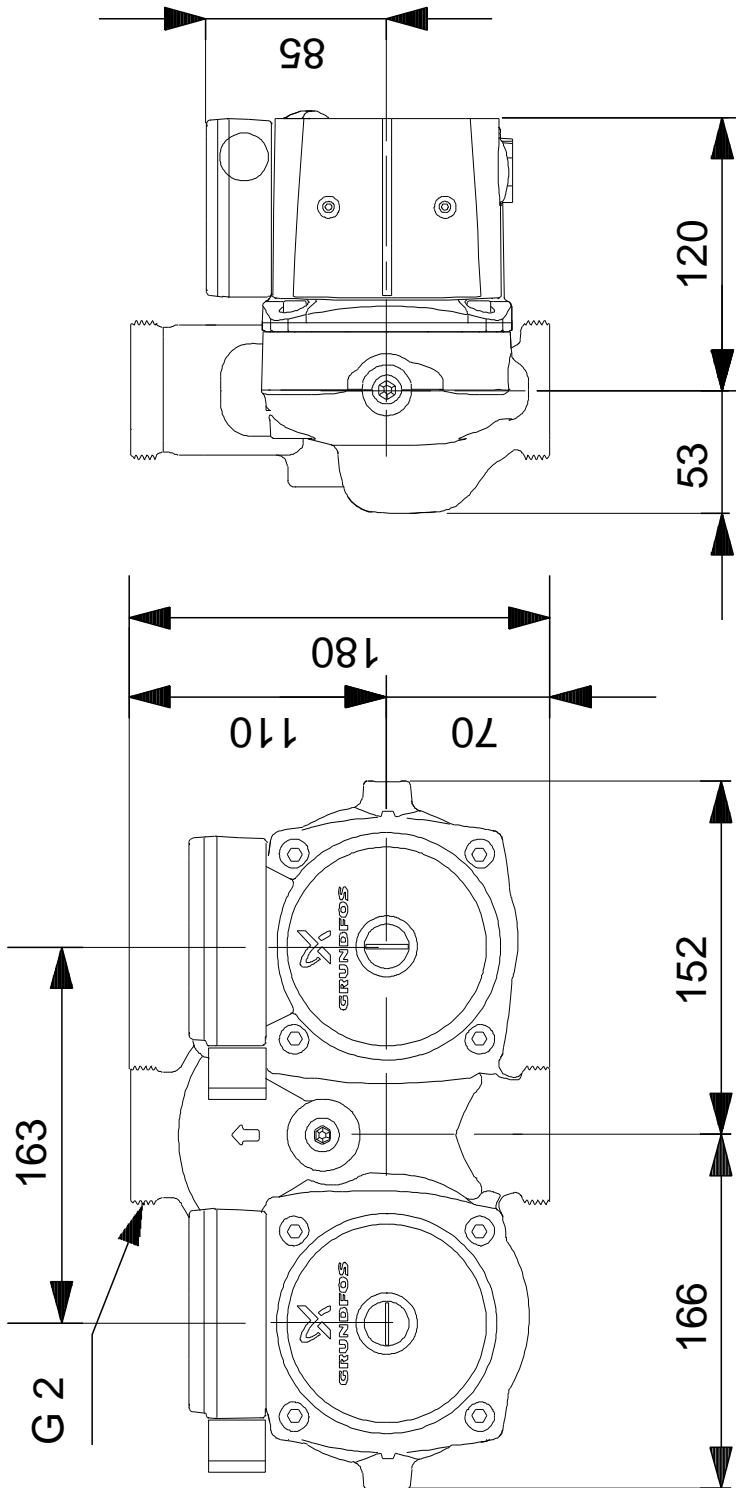

95906413 UPSD 32-50 180 50

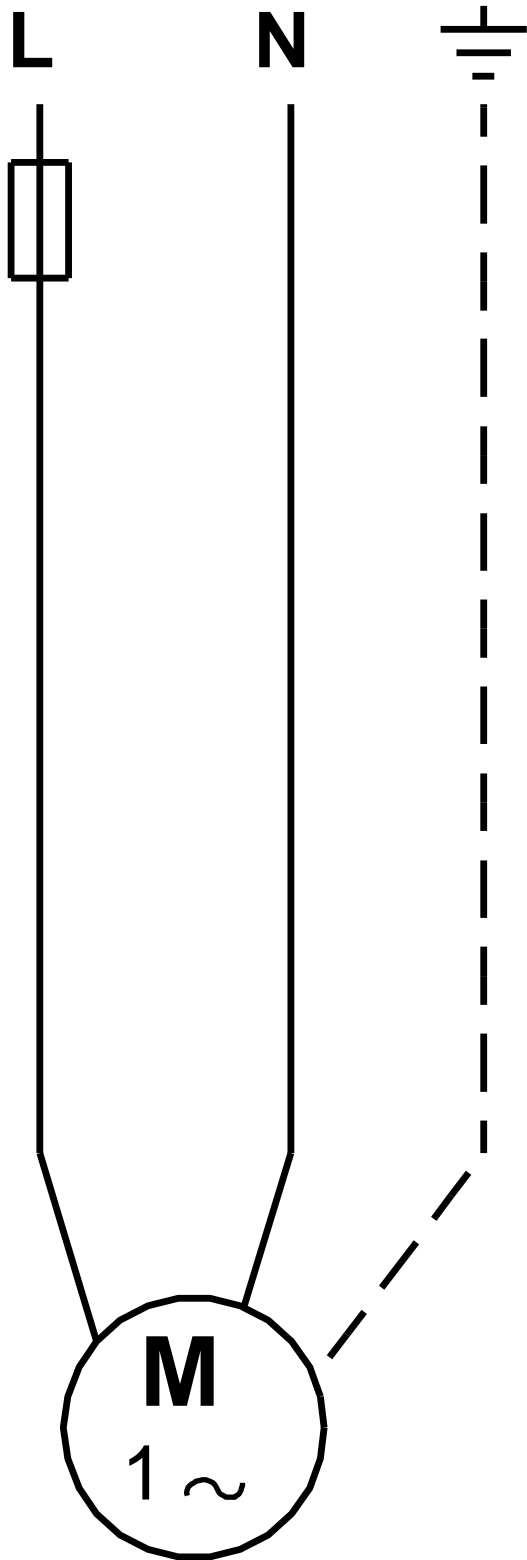

! [], .