

1 **SP 30-3N**



: 13C01903

, EN 1.4401 (AISI 316),  
MS40003

40 °C.

MP204

Grundfos Tempcon,  
(DOL).

Maximum liquid temperature: 40 °C  
 . t 0,15 / : 40 °C  
 : : 20 °C  
 : 998.2 / <sup>3</sup>

: 2900 /

: 30 <sup>3</sup>/<sub>22</sub>

: SIC/SIC  
 : CE,EAC

- : ISO9906:2012 3B  
 : T40

EN 1.4401  
 AISI AISI 316

EN 1.4401  
 AISI AISI 316

DIN W.-Nr. 1.4539  
 AISI 904 L

RP3  
 : 4 inch

: MS4000  
 - P2: 3  
 ( 2), : 3  
 : 50 Hz  
 : 3 x 380-400-415  
 : 7.70-7.85-8.10 A  
 : 460-490-500 %  
 Cos - : 0.82-0.77-0.73  
 : 2850-2865-2875 /  
 :  
 (IEC 34-5): IP68  
 (IEC 85): F  
 :  
 : 79195608  
 :  
 ErP : MEI : 0.50  
 : EuP / .  
 : 28  
 : 32.4  
 : 0.052 <sup>3</sup>  
 C : DK  
 : 8413702900

## 13C01903 SP 30-3N 50

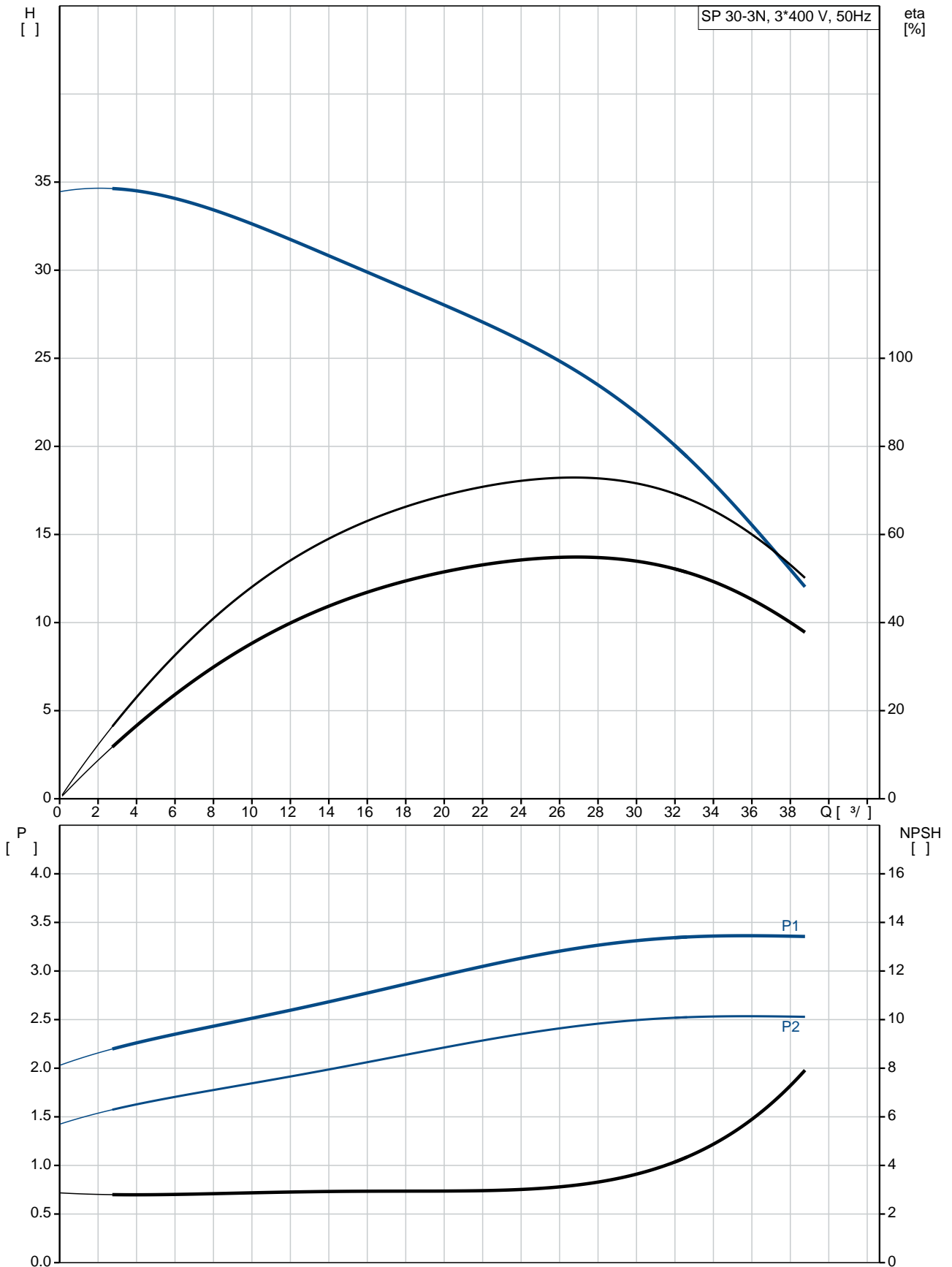

SP 30-3N  
 13C01903  
 EAN : 5700391441479

2900 /  
 30 <sup>3</sup>/<sub>l</sub>  
 22  
 3  
 NONE  
 SIC/SIC  
 CE,EAC  
 ISO9906:2012 3B  
 B  
 YES  
 T40

EN 1.4401  
 AISI AISI 316  
 EN 1.4401  
 AISI AISI 316  
 DIN W.-Nr. 1.4539  
 AISI 904 L

RP3  
 4 inch

Maximum liquid temperature: 40 °C  
 . t 0,15 / : 40 °C  
 20 °C  
 998.2 / <sup>3</sup>

MS4000  
 GRUNDFOS  
 - P2: 3  
 ( 2), 3

50 Hz  
 3 x 380-400-415  
 7.70-7.85-8.10 A  
 460-490-500 %  
 Cos - : 0.82-0.77-0.73  
 2850-2865-2875 /

(IEC 34-5): IP68  
 (IEC 85): F

79195608

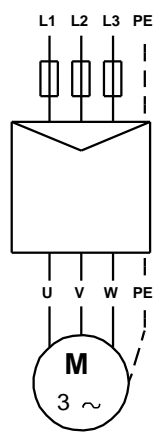
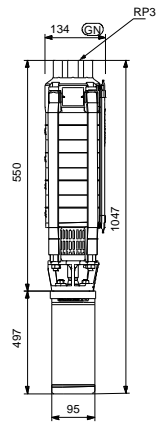
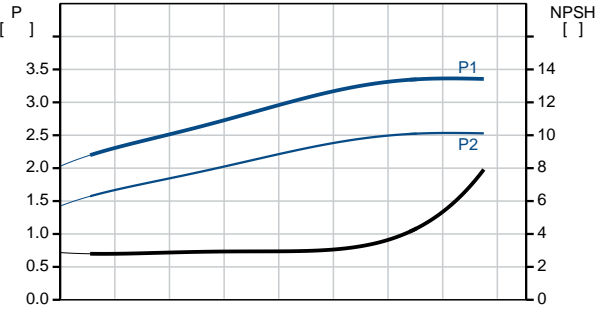
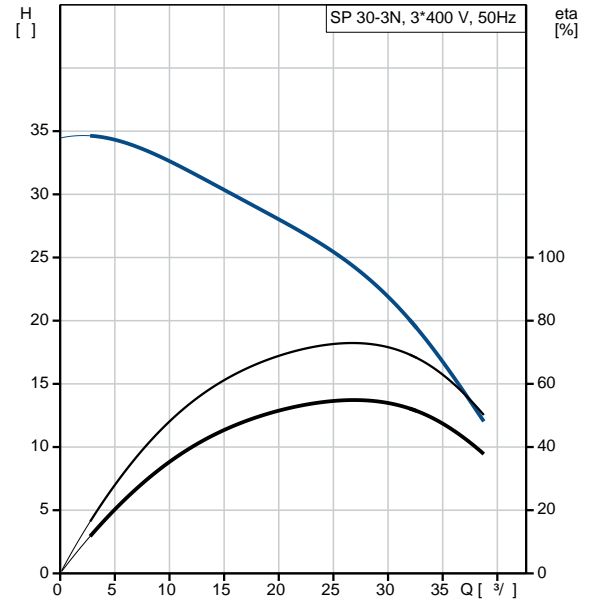

		MEI :	0.50
ErP	:	EuP	/ .
	:		28
	:		32.4
	:		0.052 <sup>3</sup>
C	:	DK	
	:		8413702900

## 13C01903 SP 30-3N 50

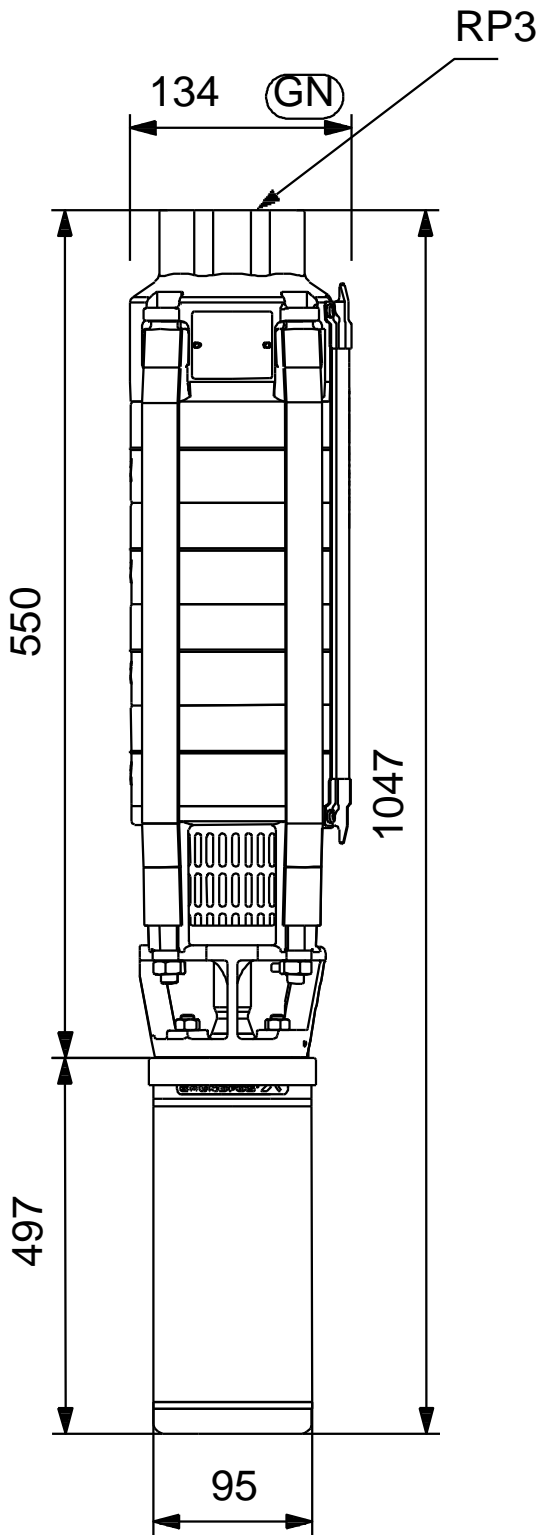

**13C01903 SP 30-3N 50**

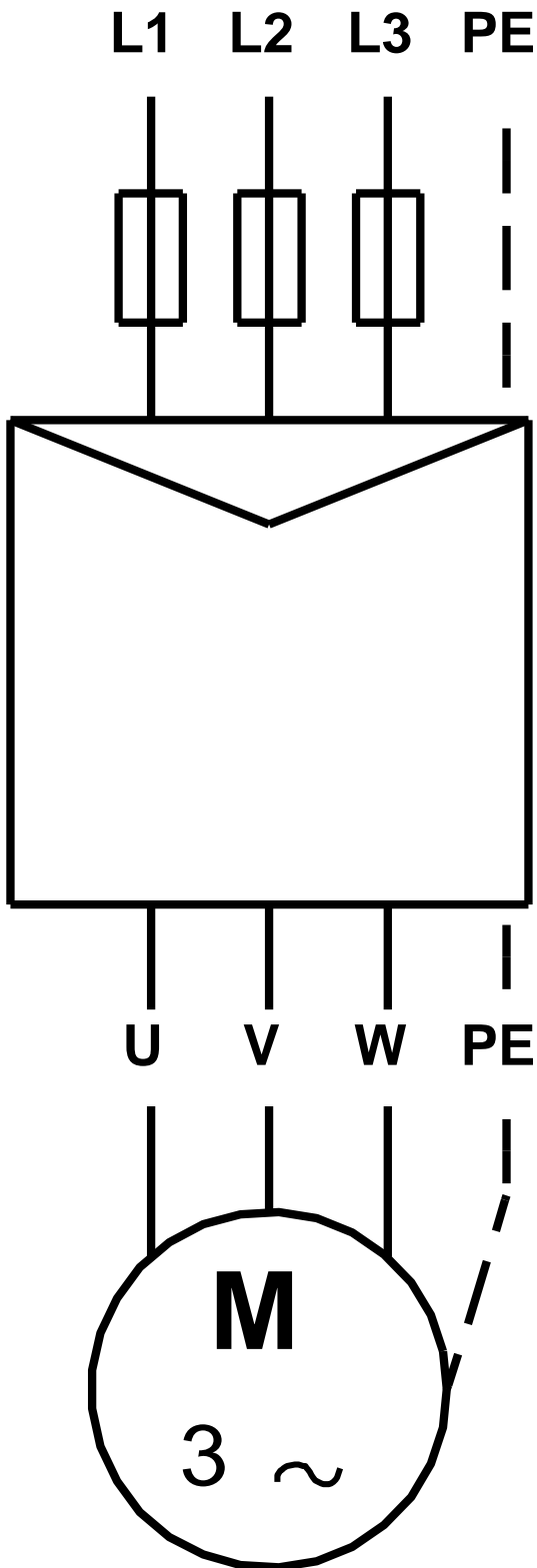

! [ ], .