

1 **SP 30-2N**



: 13C01902

, EN 1.4401 (AISI 316),
MS40002.2

40 °C.

MP204

Grundfos Tempcon,
(DOL).

Maximum liquid temperature: 40 °C
0,15 / : 40 °C
: 20 °C
998.2 / ³

: 2900 /

30 ³/₁₅

: SIC/SIC
: CE,EAC

- : ISO9906:2012 3B
: T40

EN 1.4401
AISI AISI 316

EN 1.4401
AISI AISI 316

DIN W.-Nr. 1.4539
AISI 904 L

RP3
: 4 inch

: MS4000
 - P2: 2.2
 (2), : 2.2
 : 50 Hz
 : 3 x 380-400-415
 : 5.75-6.00-6.30 A
 : 440-450-450 %
 Cos - : 0.82-0.76-0.71
 : 2840-2860-2870 /
 :
 (IEC 34-5): IP68
 (IEC 85): F
 :
 : 79195607
 :
 ErP : MEI : 0.50
 : EuP / .
 : 24
 : 26.6
 : 0.032 ³
 Danish VVS No.: 388368020
 C : DK
 : 8413702900

13C01902 SP 30-2N 50

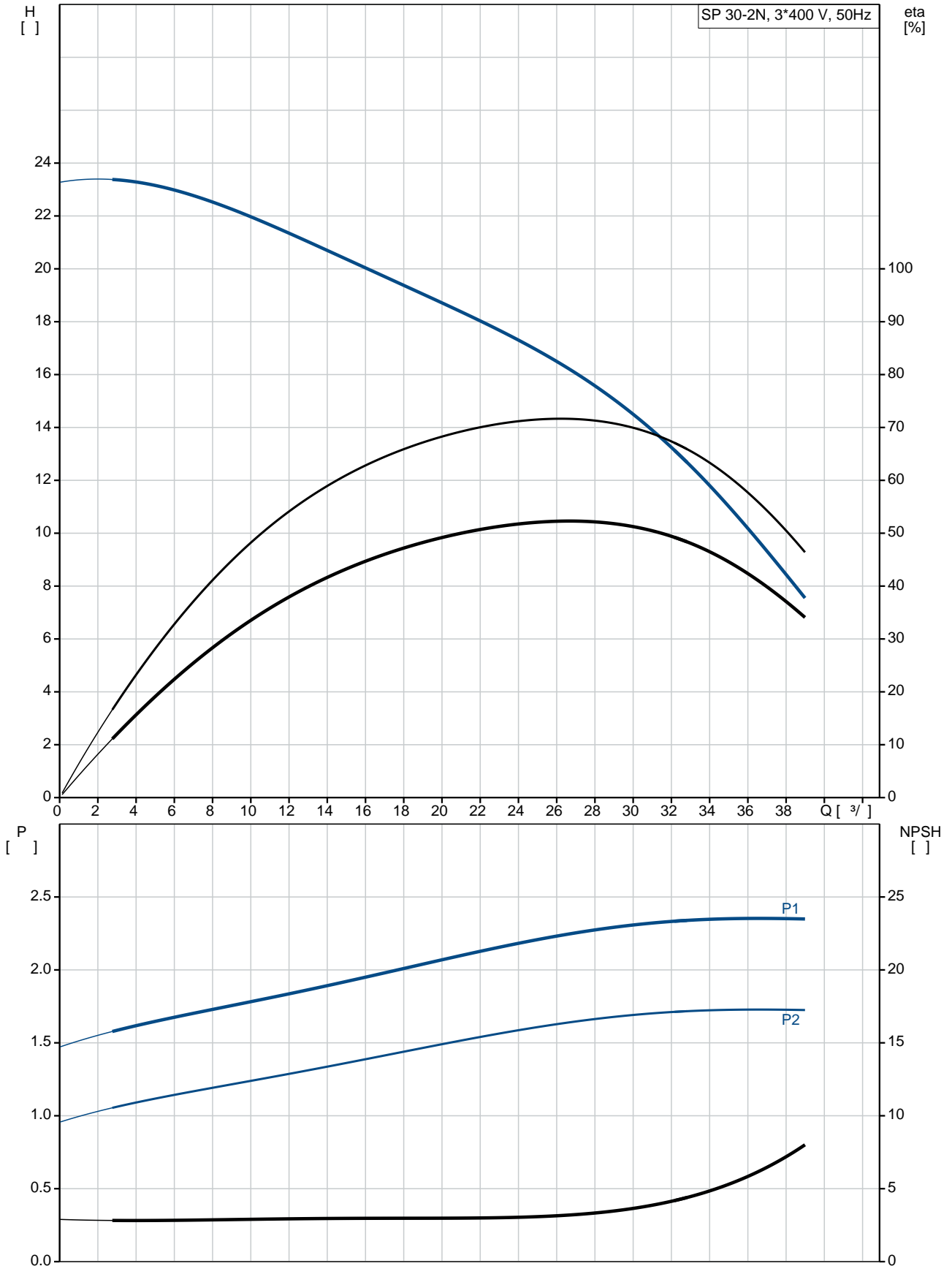

SP 30-2N
 13C01902
 EAN : 5700391441448

2900 /
 30 ³/_l
 15
 2
 NONE
 SIC/SIC
 CE,EAC
 ISO9906:2012 3B
 B
 YES
 T40

EN 1.4401
 AISI AISI 316
 EN 1.4401
 AISI AISI 316
 DIN W.-Nr. 1.4539
 AISI 904 L

RP3
 4 inch

Maximum liquid temperature: 40 °C
 . t 0,15 / : 40 °C
 20 °C
 998.2 / ³

MS4000
 GRUNDFOS
 - P2: 2.2
 (2), 2.2

50 Hz
 3 x 380-400-415
 5.75-6.00-6.30 A
 440-450-450 %
 Cos - : 0.82-0.76-0.71
 2840-2860-2870 /

(IEC 34-5): IP68
 (IEC 85): F

79195607

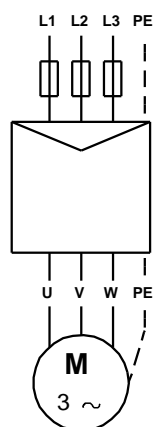
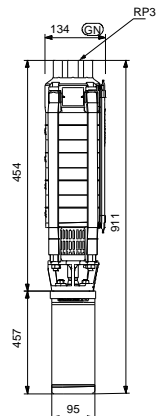
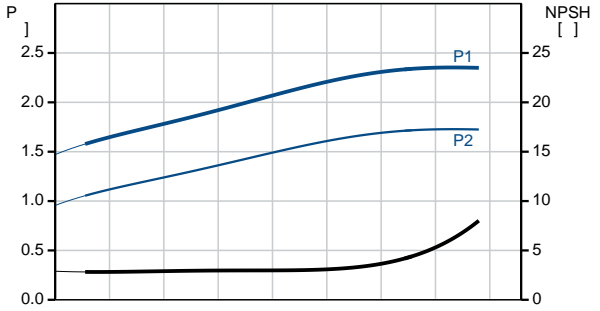
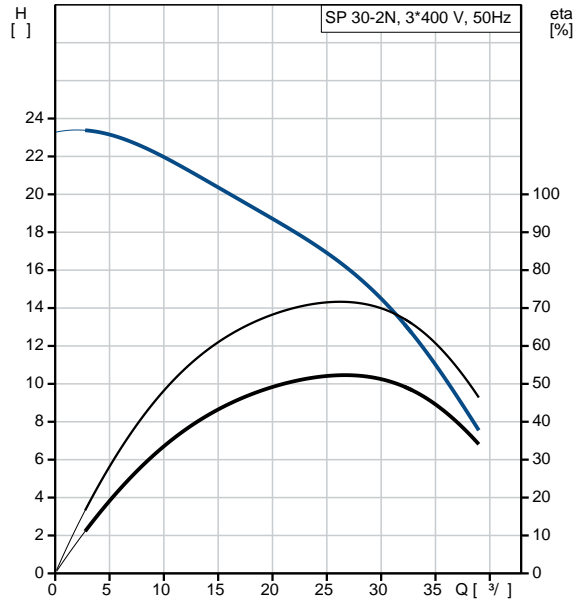

MEI :	0.50
ErP :	EuP / .
:	24
:	26.6
:	0.032 ³
Danish VVS No.:	388368020
C :	DK
:	8413702900

13C01902 SP 30-2N 50

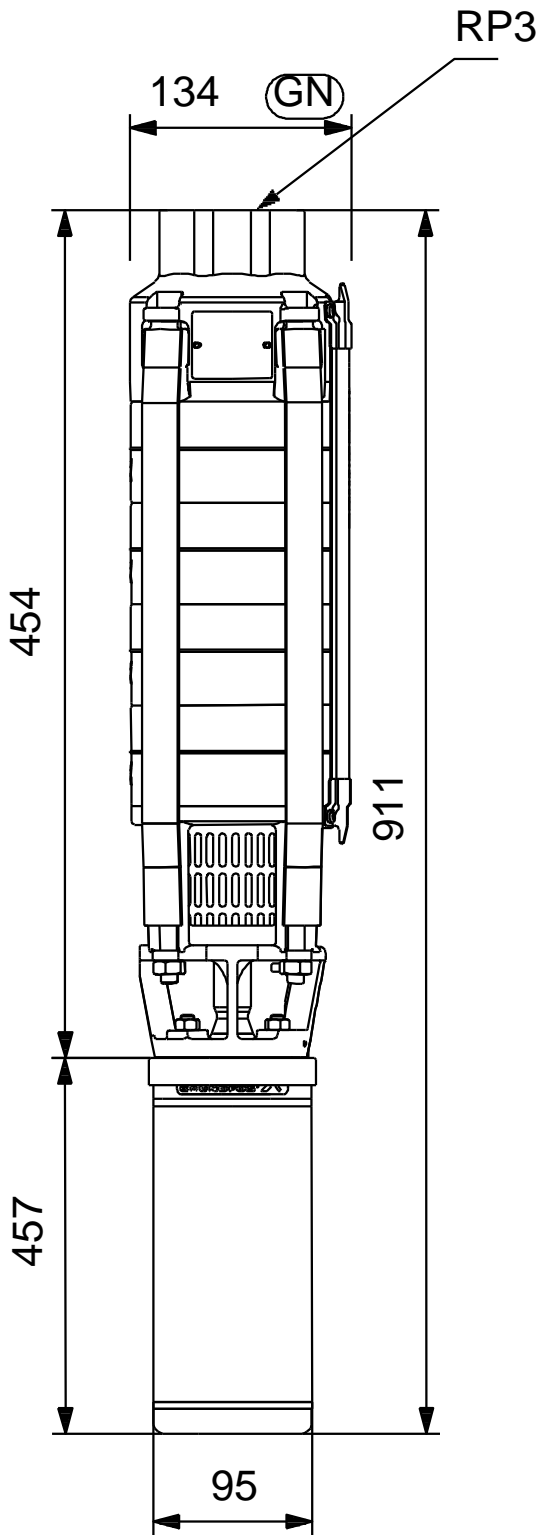

13C01902 SP 30-2N 50

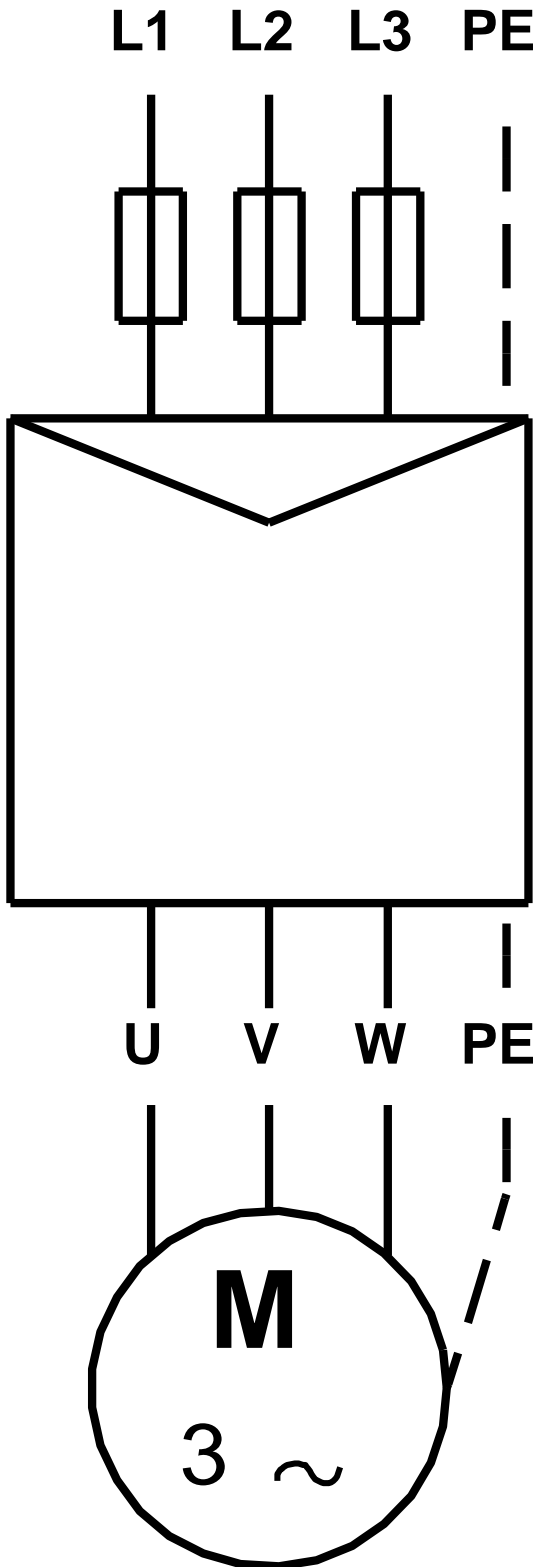

!

[],