

1 **SP 30-1N**



: 13C01901

, EN 1.4401 (AISI 316),
MS40001.1

40 °C.

MP204

Grundfos Tempcon,
(DOL).

Maximum liquid temperature: 40 °C
0,15 / : 40 °C
: 20 °C
998.2 / ³

: 2900 /

30 ³/₇

: SIC/SIC
: CE,EAC
- : ISO9906:2012 3B
: T40

EN 1.4401
AISI AISI 316

EN 1.4401
AISI AISI 316

DIN W.-Nr. 1.4539
AISI 904 L

RP3
: 4 inch

: MS4000
 - P2: 1.1
 (2), : 1.1
 : 50 Hz
 : 3 x 380-400-415
 : 2.80-2.75-2.75 A
 : 440-480-500 %
 Cos - : 0.85-0.82-0.78
 : 2850-2870-2880 /
 :
 (IEC 34-5): IP68
 (IEC 85): F
 :
 : 79195605
 :
 ErP : MEI : 0.50
 : EuP /
 : 20.1
 : 22.7
 : 0.032 ³
 C : DK
 : 8413702900

13C01901 SP 30-1N 50

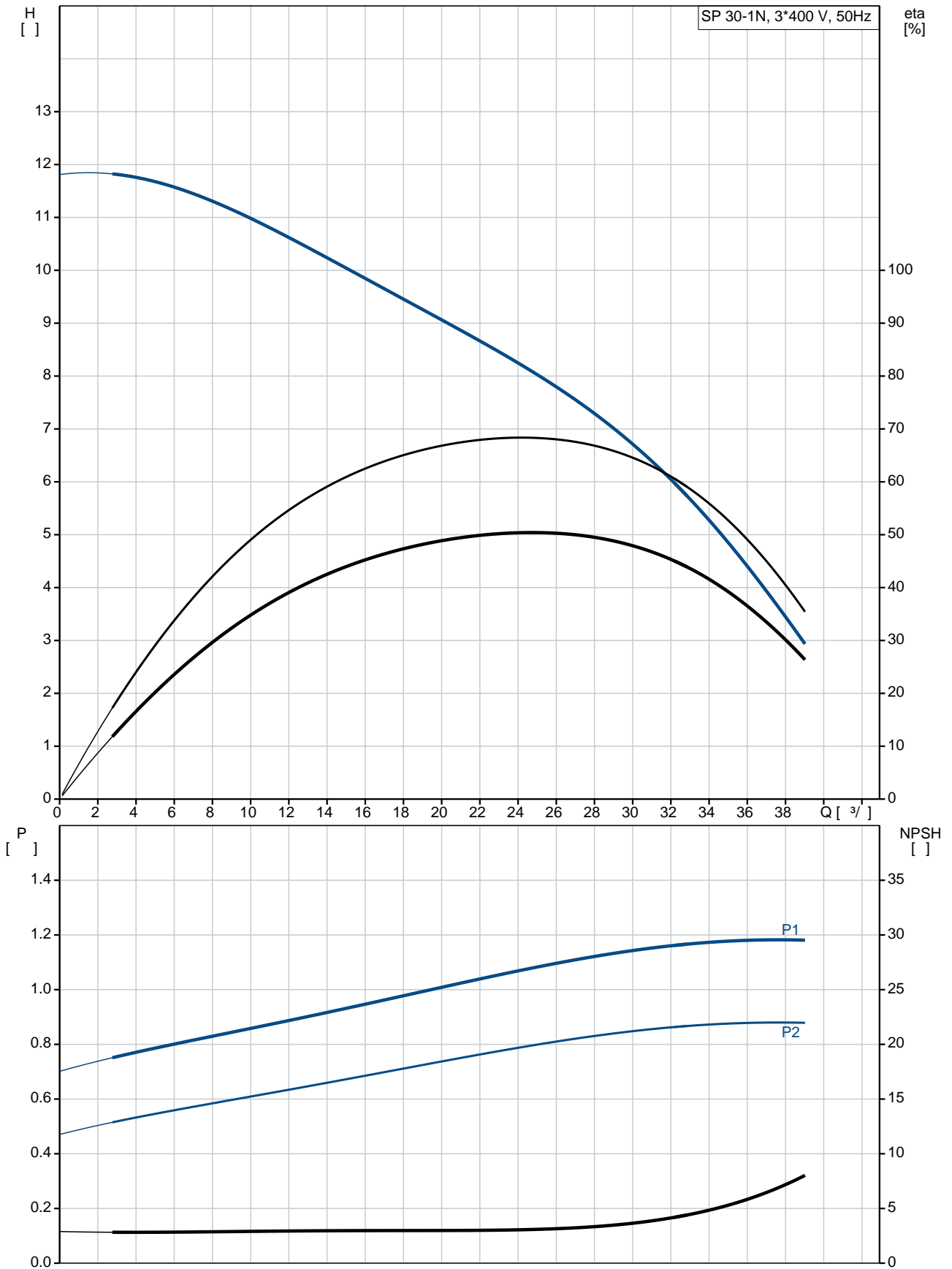

SP 30-1N
 13C01901
 EAN : 5700391441417

2900 /
 30 ³/_l
 7
 1
 NONE
 SIC/SIC
 CE,EAC
 ISO9906:2012 3B
 B
 YES
 T40

EN 1.4401
 AISI AISI 316
 EN 1.4401
 AISI AISI 316
 DIN W.-Nr. 1.4539
 AISI 904 L

RP3
 4 inch

Maximum liquid temperature: 40 °C
 . t 0,15 / : 40 °C
 20 °C
 998.2 / ³

MS4000
 GRUNDFOS
 - P2: 1.1
 (2), 1.1

50 Hz
 3 x 380-400-415
 2.80-2.75-2.75 A
 440-480-500 %
 Cos - : 0.85-0.82-0.78
 2850-2870-2880 /

(IEC 34-5): IP68
 (IEC 85): F

79195605

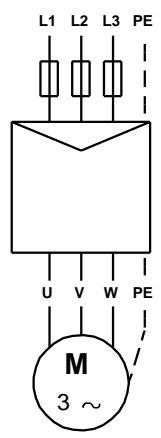
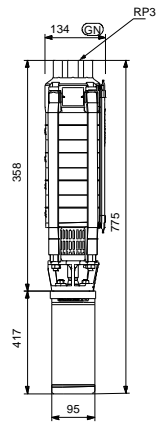
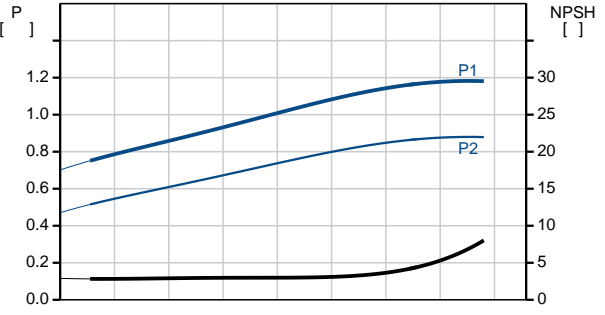
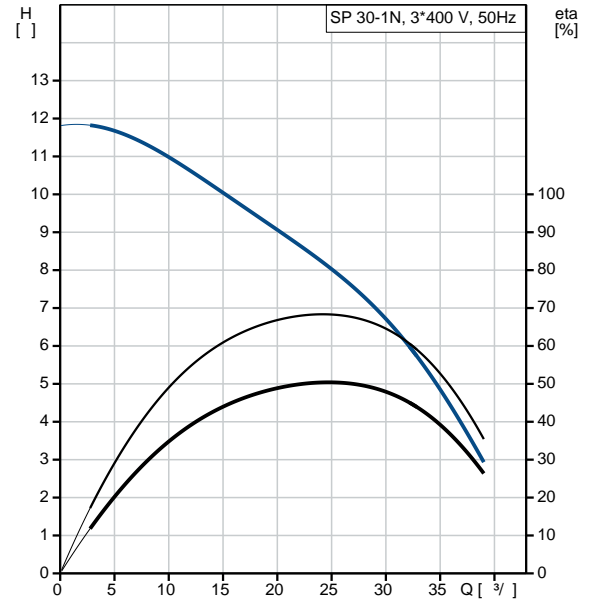

		MEI :	0.50
ErP	:	EuP	/ .
	:		20.1
	:		22.7
	:		0.032 ³
C	:	DK	
	:		8413702900

13C01901 SP 30-1N 50

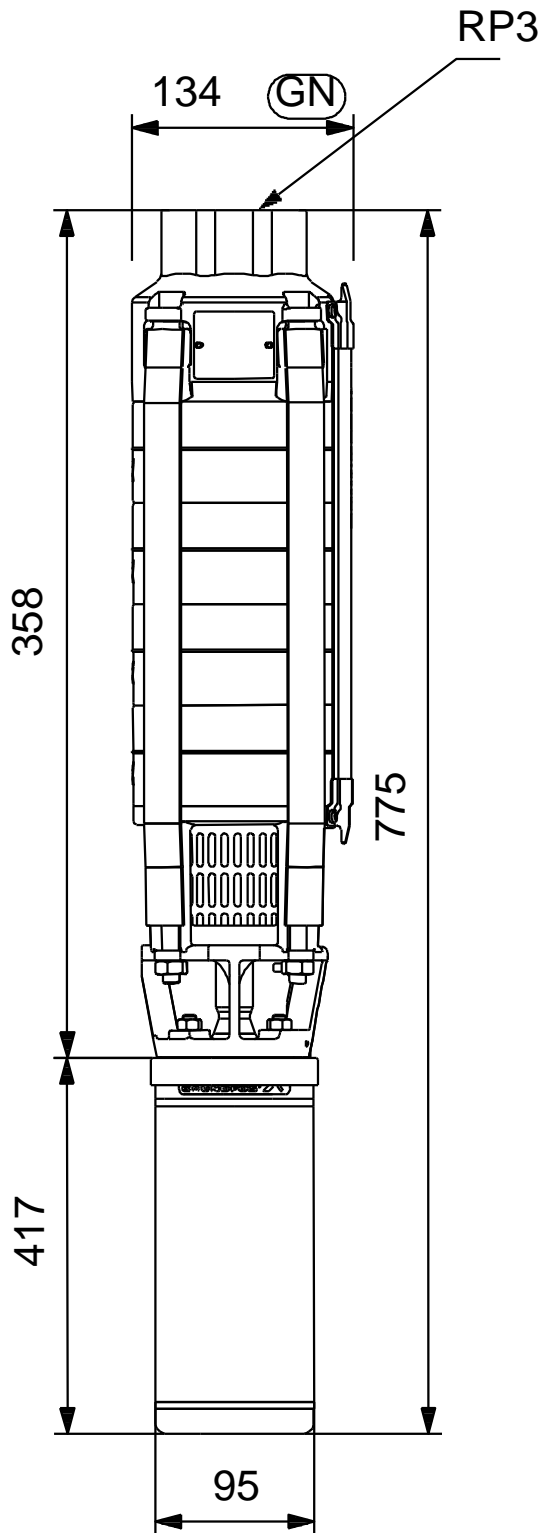

13C01901 SP 30-1N 50

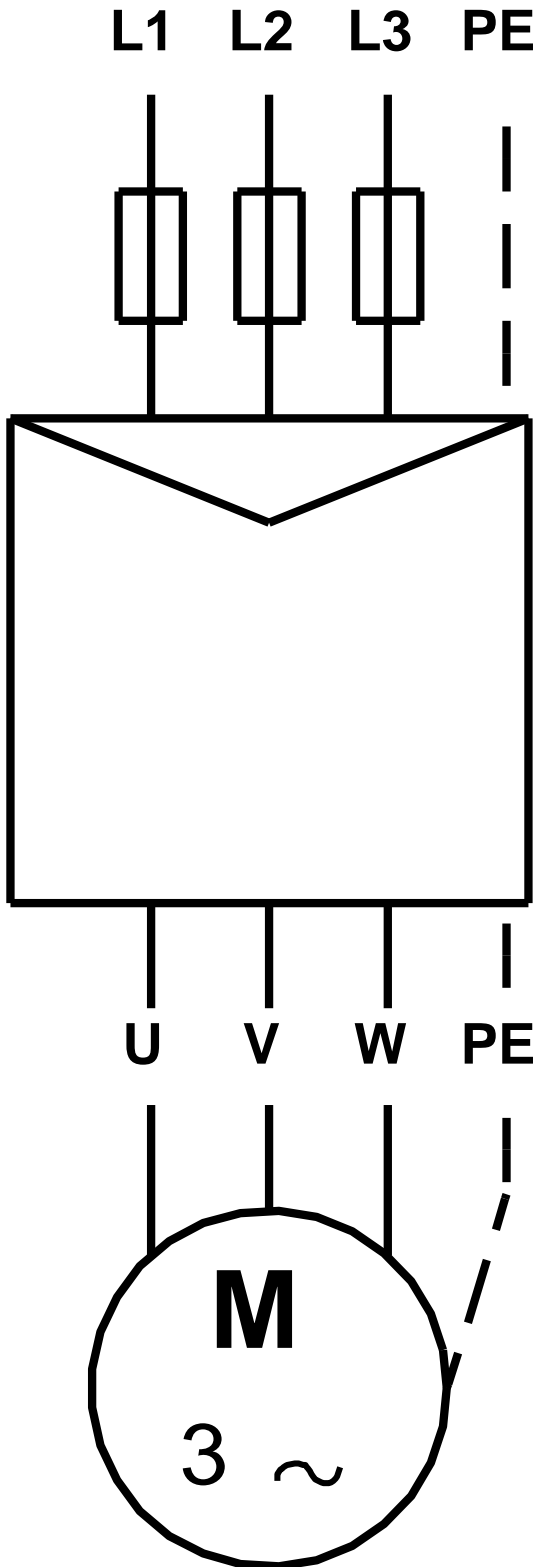

! [], .