

1 SP 30-4



: 13A01904

, EN 1.4301 (AISI 304),

MS40004

40 °C.

Pt1000.
(DOL).

Maximum liquid temperature: 40 °C
 . t 0,15 / : 40 °C
 : 20 °C
 : 998.2 / ³

: 2900 /

: 30 ³/
 : 30

: HM/CER
 : CE,EAC
 - : ISO9906:2012 3B
 : T40

EN 1.4301
 AISI AISI 304

EN 1.4301
 AISI AISI 304

DIN W.-Nr. 1.4301
 AISI 304

: RP3
 : 4 inch

: MS4000
 - P2: 4
 (2), : 4
 : 50 Hz
 : 3 x 380-400-415
 : 9.75-9.60-9.80 A
 : 460-500-530 %
 Cos - : 0.85-0.80-0.77
 : 2850-2865-2875 /
 :
 (IEC 34-5): IP68
 (IEC 85): F
 :
 : 79194510
 :
 ErP : MEI : 0.50
 : EuP /
 : 33.9
 : 38.4
 : 0.052 ³
 Danish VVS No.: 388338040
 Finnish LVI No.: 4762733
 C : DK
 : 8413702900

13A01904 SP 30-4 50

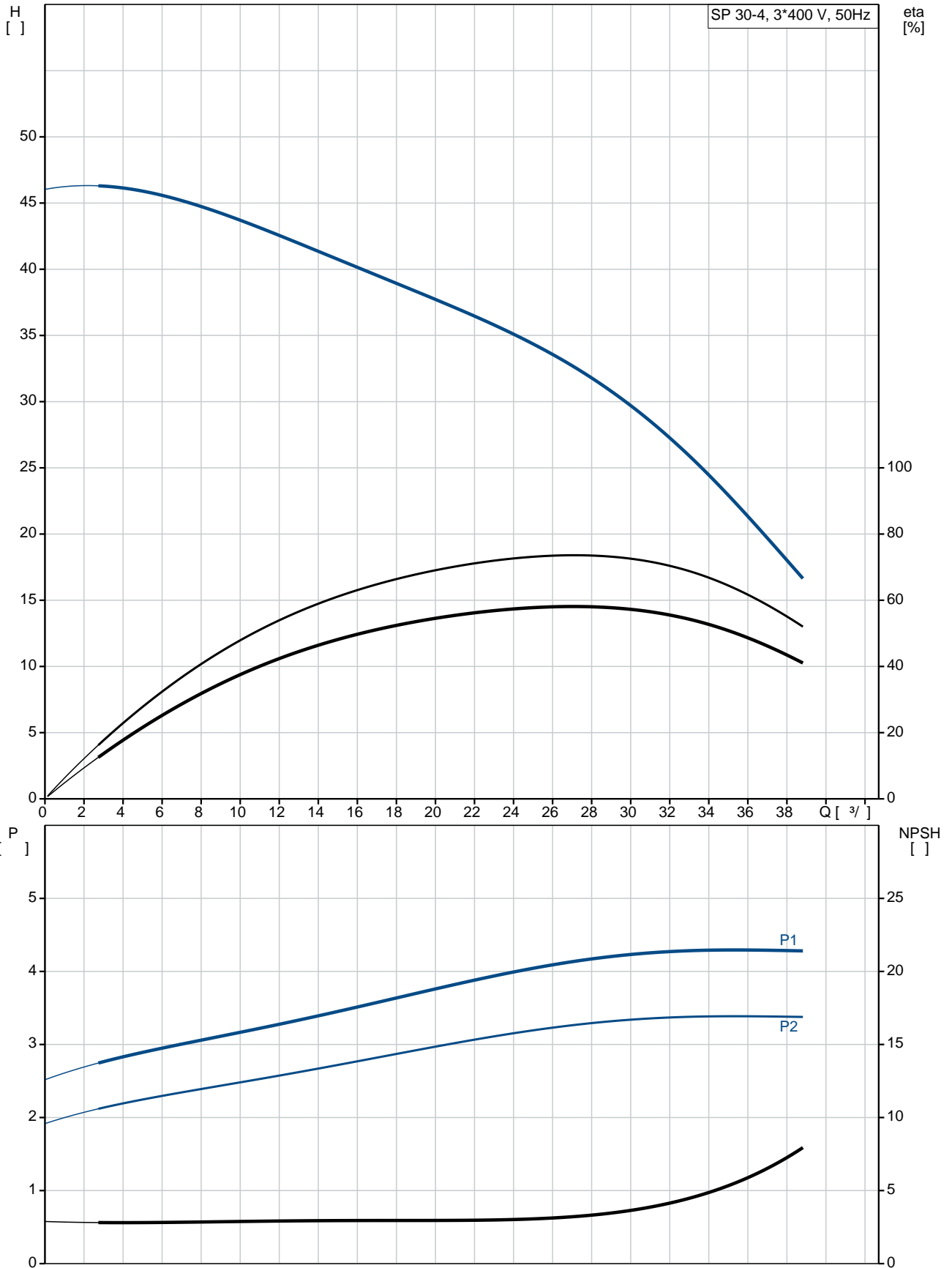

SP 30-4
 EAN : 13A01904
 5700390381073

2900 /
 30 ³/₄
 30
 4
 NONE
 HM/CER
 CE,EAC
 ISO9906:2012 3B
 B
 YES
 T40

EN 1.4301
 AISI AISI 304
 EN 1.4301
 AISI AISI 304
 DIN W.-Nr. 1.4301
 AISI 304

RP3
 4 inch

Maximum liquid temperature: 40 °C
 . t 0,15 / : 40 °C
 20 °C
 998.2 / ³

MS4000
 GRUNDFOS
 - P2: 4
 (2), 4

50 Hz
 3 x 380-400-415
 9.75-9.60-9.80 A
 460-500-530 %
 Cos - : 0.85-0.80-0.77
 2850-2865-2875 /

(IEC 34-5): IP68
 (IEC 85): F

79194510

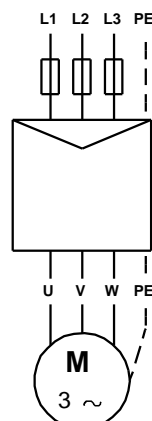
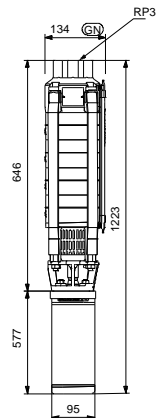
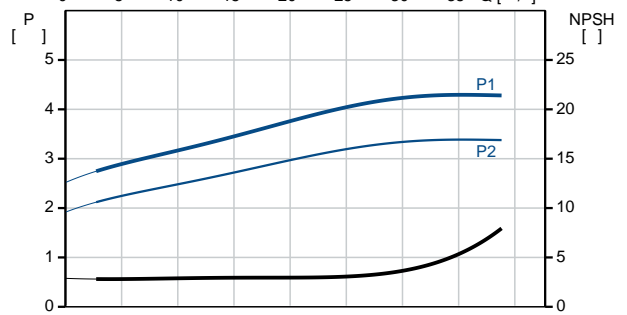
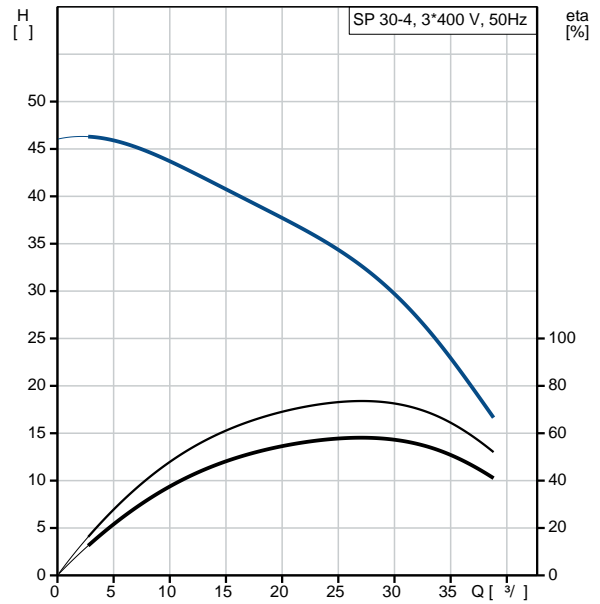

MEI :	0.50
ErP :	EuP / .
:	33.9
:	38.4
:	0.052 ³
Danish VVS No.:	388338040
Finnish LVI No.:	4762733
C :	DK
:	8413702900

13A01904 SP 30-4 50

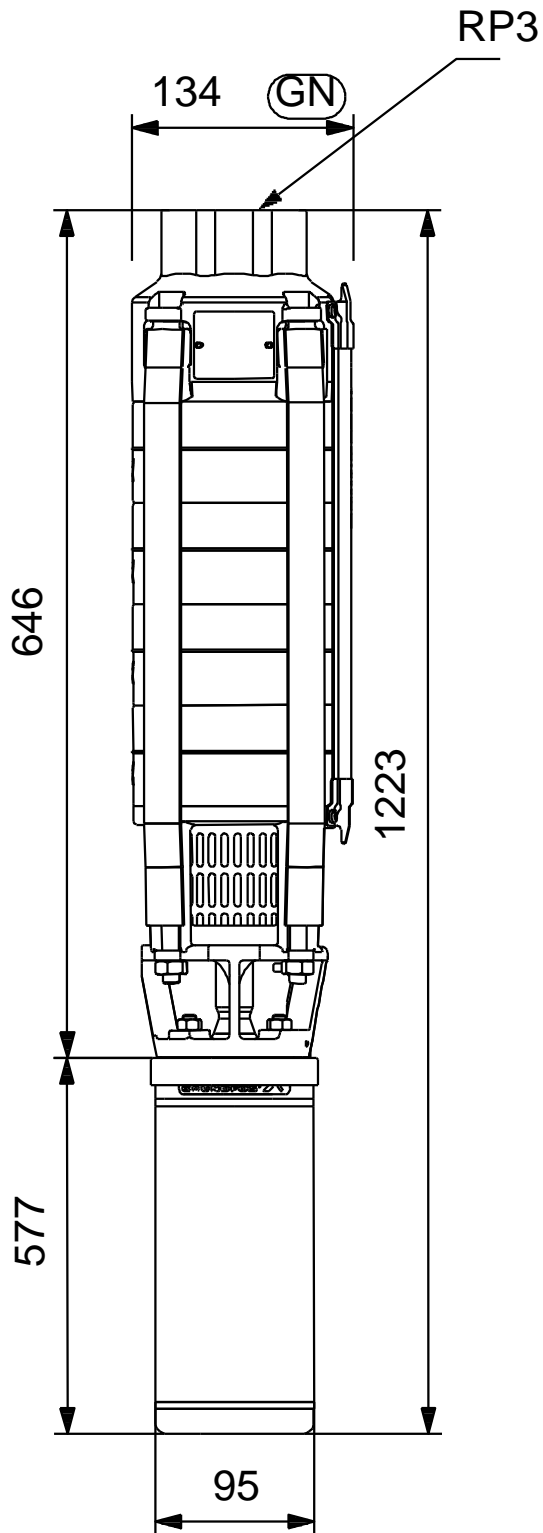

13A01904 SP 30-4 50

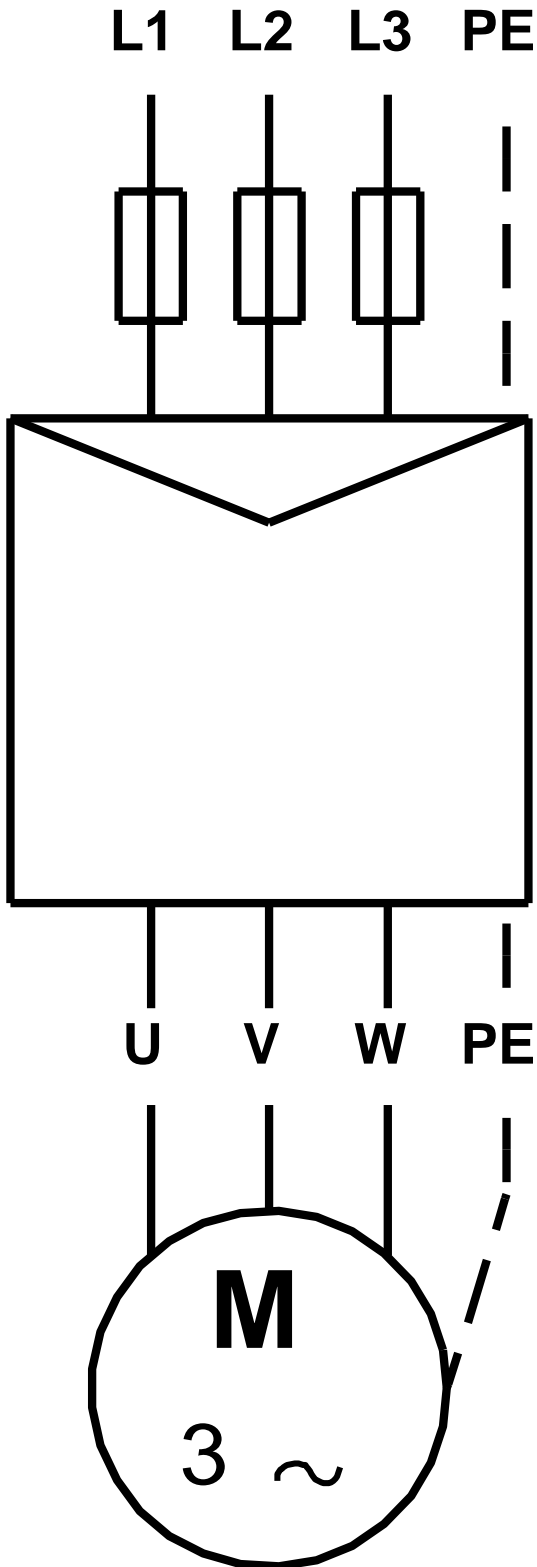

!

[],