

1 SP 30-3



: 13A01903

, EN 1.4301 (AISI 304),

MS40003

40 °C.

Pt1000.
(DOL).

Maximum liquid temperature: 40 °C
 . t 0,15 / : 40 °C
 : 20 °C
 : 998.2 / ³

: 2900 /

: 30 ³/
 : 22
 : HM/CER
 : CE,EAC
 - : ISO9906:2012 3B
 : T40

EN 1.4301
 AISI AISI 304

EN 1.4301
 AISI AISI 304

DIN W.-Nr. 1.4301
 AISI 304

RP3
 : 4 inch

: MS4000
 - P2: 3
 (2), : 3
 : 50 Hz
 : 3 x 380-400-415
 : 7.70-7.85-8.10 A
 : 460-490-500 %
 Cos - : 0.82-0.77-0.73
 : 2850-2865-2875 /
 :
 (IEC 34-5): IP68
 (IEC 85): F
 :
 : 79194508
 :
 ErP : MEI : 0.50
 : EuP /
 : 28
 : 32.4
 : 0.052 ³
 Danish VVS No.: 388338030
 Finnish LVI No.: 4762732
 C : DK
 : 8413702900

13A01903 SP 30-3 50

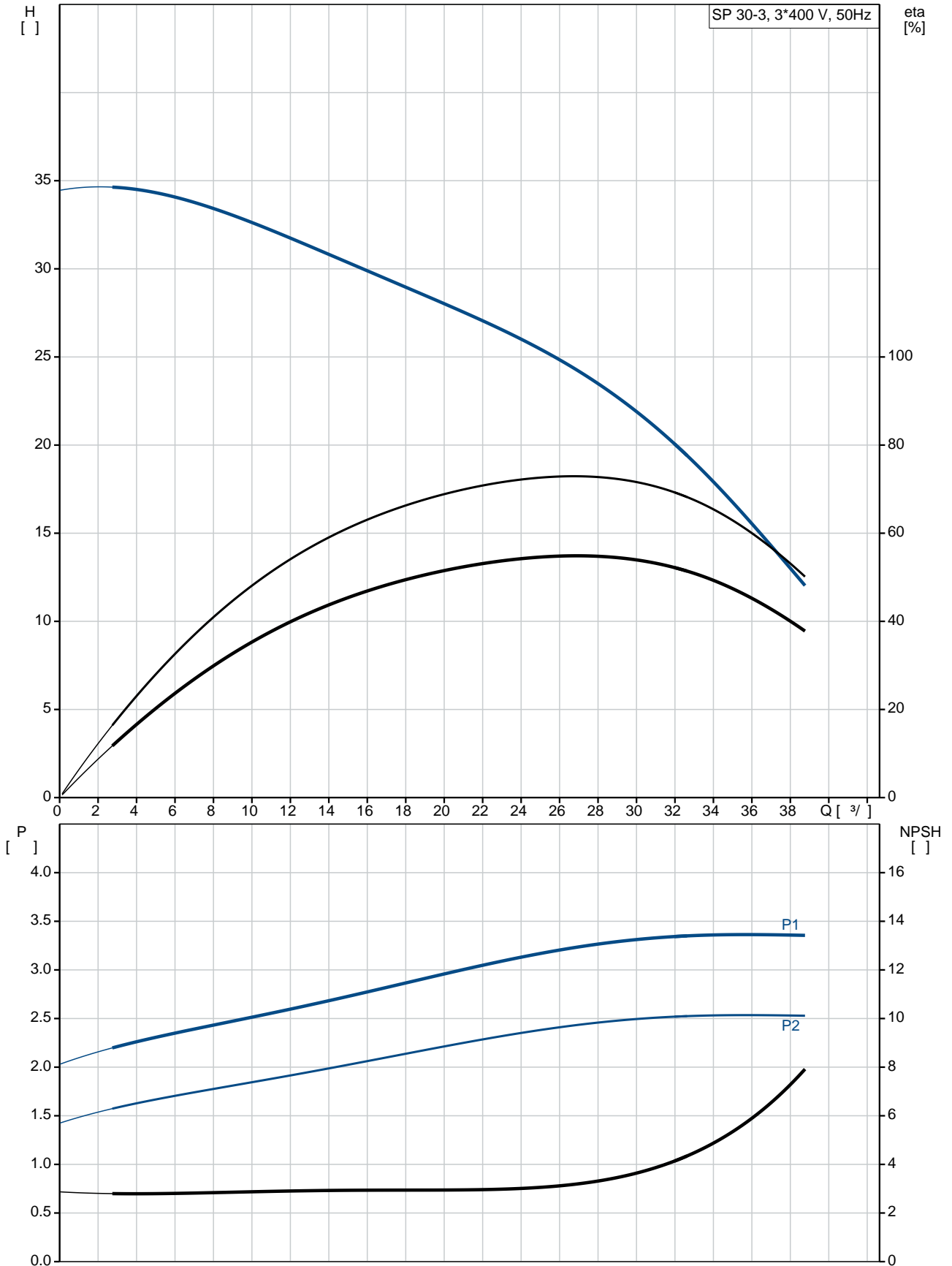

SP 30-3
 EAN : 13A01903
 5700391137709

2900 /
 30 ³/_l
 22
 3
 NONE
 HM/CER
 CE,EAC
 ISO9906:2012 3B
 B
 YES
 T40

EN 1.4301
 AISI AISI 304
 EN 1.4301
 AISI AISI 304
 DIN W.-Nr. 1.4301
 AISI 304

RP3
 4 inch

Maximum liquid temperature: 40 °C
 . t 0,15 / : 40 °C
 20 °C
 998.2 / ³

MS4000
 GRUNDFOS
 - P2: 3
 (2), 3

50 Hz
 3 x 380-400-415
 7.70-7.85-8.10 A
 460-490-500 %
 Cos - : 0.82-0.77-0.73
 2850-2865-2875 /

(IEC 34-5): IP68
 (IEC 85): F

79194508

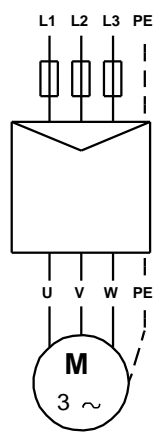
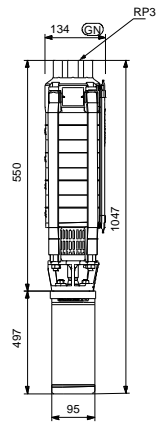
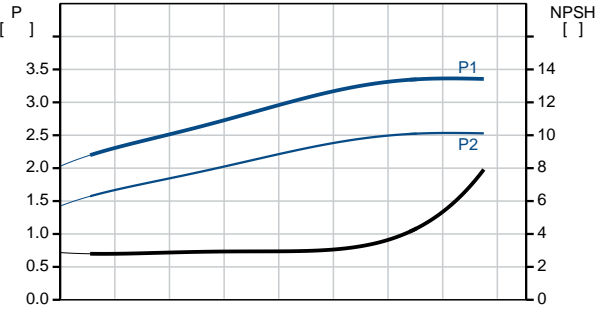
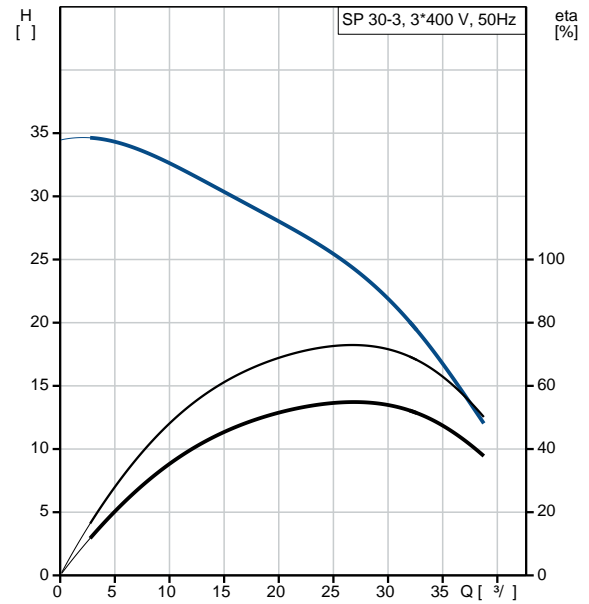

MEI :		0.50
ErP :	EuP	/ .
:		28
:		32.4
:		0.052 ³
Danish VVS No.:		388338030
Finnish LVI No.:		4762732
C :	DK	
:		8413702900

13A01903 SP 30-3 50

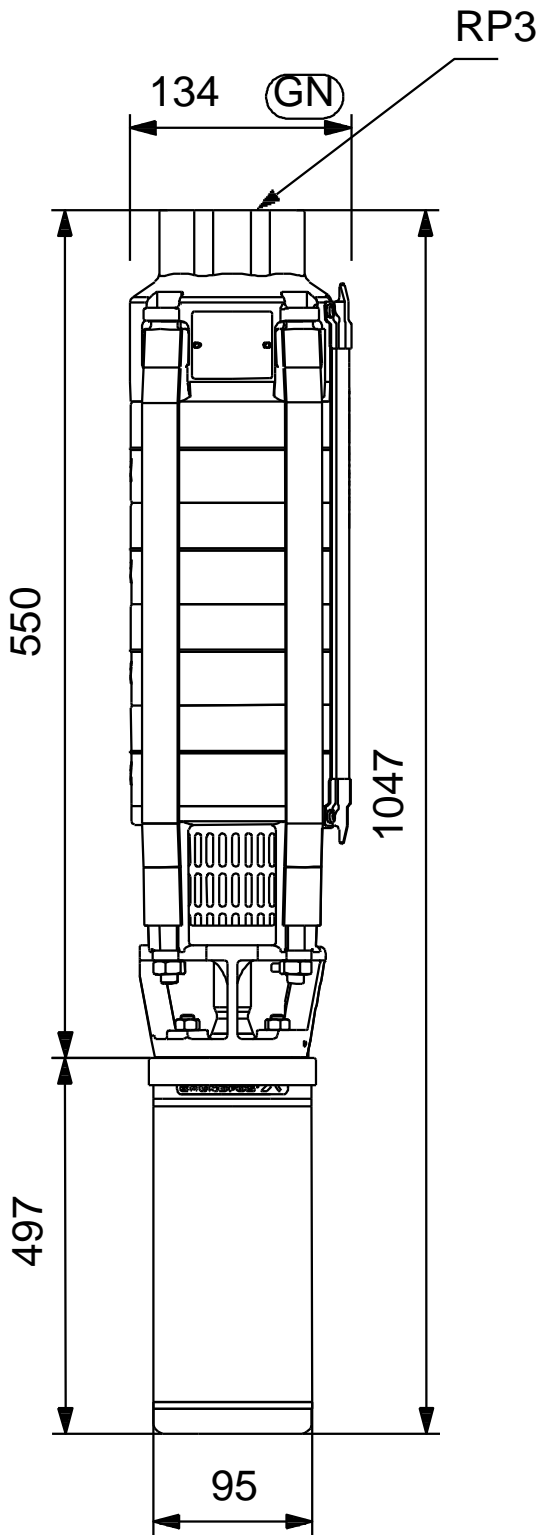

13A01903 SP 30-3 50

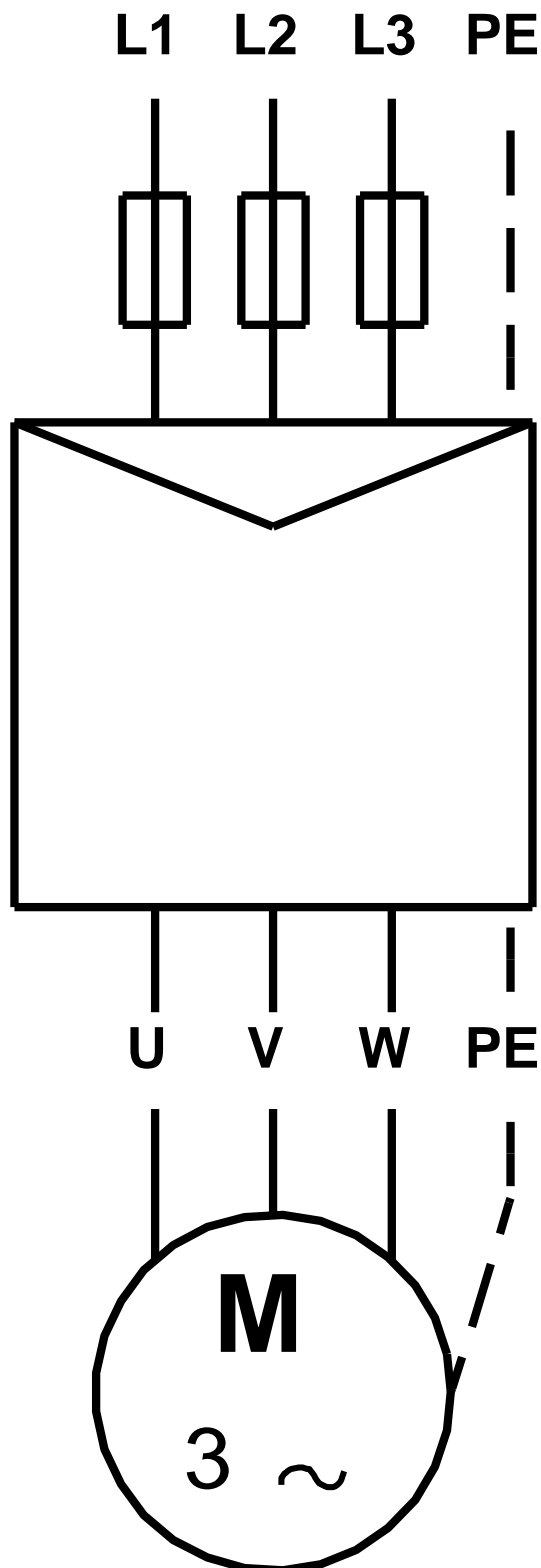

! [], .