

1 SP 30-2



: 13A01902

, EN 1.4301 (AISI 304),

MS4022.2

40 °C.

Pt1000.
(DOL).

Maximum liquid temperature: 40 °C
 . t 0,15 / : 40 °C
 : 20 °C
 : 998.2 / ³

: 2900 /

: 30 ³/₁₅

: LIPSEAL

: CE,EAC

- : ISO9906:2012 3B

: T40

EN 1.4301
AISI AISI 304

EN 1.4301
AISI AISI 304

DIN W.-Nr. 1.4301
AISI 304

RP3
: 4 inch

: MS402
 - P2: 2.2
 (2), : 2.2
 : 50 Hz
 : 3 x 380-400-415
 : 5.50-5.50-5.70 A
 : 440-460-470 %
 Cos - : 0.85-0.82-0.77
 : 2850-2860-2870 /
 :
 (IEC 34-5): IP68
 (IEC 85): B
 :
 : 79192007
 :
 ErP : MEI : 0.50
 : EuP / .
 : 20.9
 : 23.5
 : 0.032 ³
 Danish VVS No.: 388338020
 Finnish LVI No.: 4762731
 C : DK
 : 8413702900

13A01902 SP 30-2 50

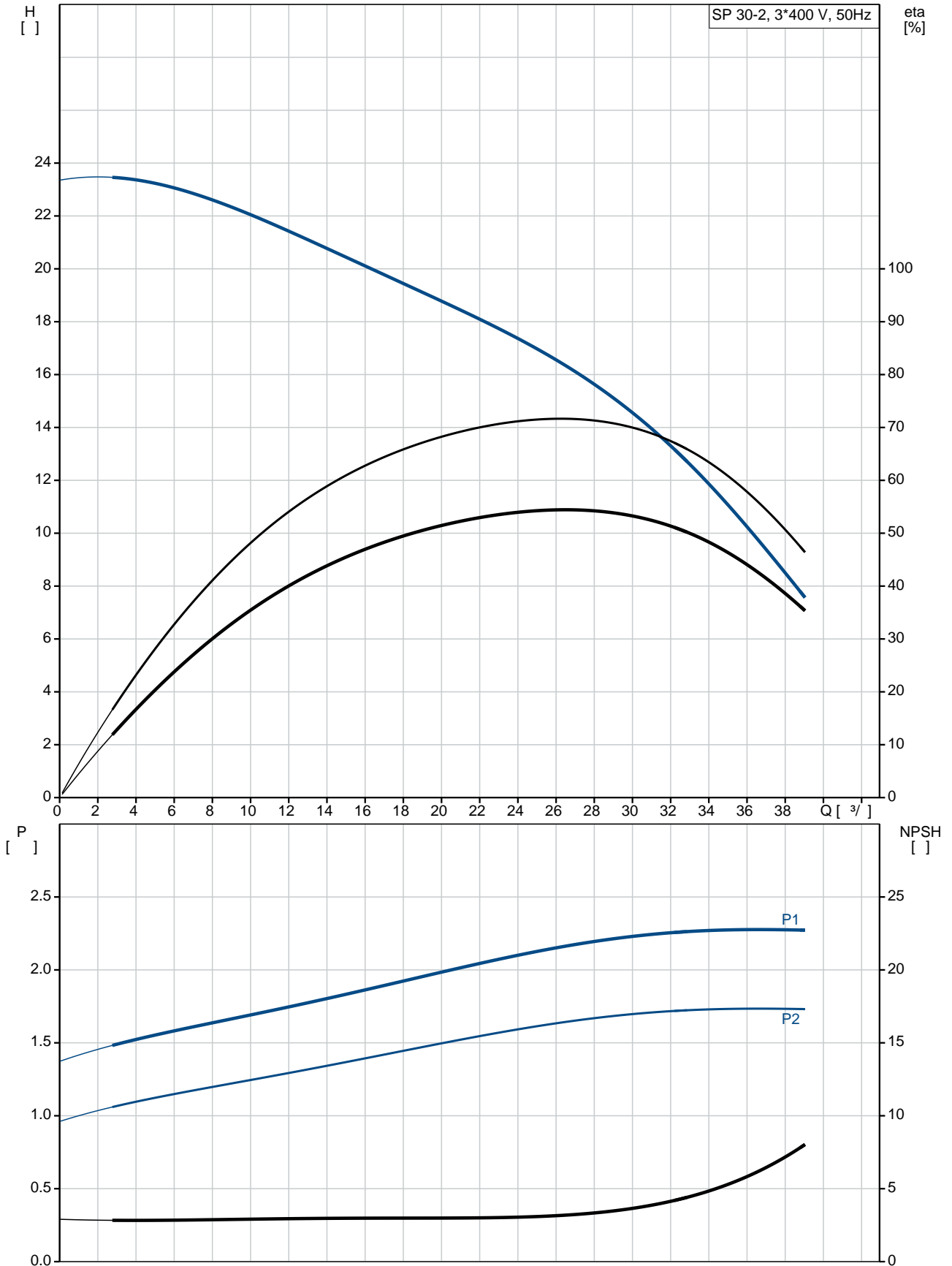

SP 30-2
 13A01902
 EAN : 5700391137662

2900 /
 30 ^{3/}
 15
 2
 NONE
 LIPSEAL
 CE,EAC
 ISO9906:2012 3B
 B
 YES
 T40

EN 1.4301
 AISI AISI 304
 EN 1.4301
 AISI AISI 304
 DIN W.-Nr. 1.4301
 AISI 304

RP3
 4 inch

Maximum liquid temperature: 40 °C
 . t 0,15 / : 40 °C
 20 °C
 998.2 / ³

MS402
 GRUNDFOS
 - P2: 2.2
 (2), 2.2

50 Hz
 3 x 380-400-415
 5.50-5.50-5.70 A
 440-460-470 %
 Cos - : 0.85-0.82-0.77
 2850-2860-2870 /

(IEC 34-5): IP68
 (IEC 85): B

79192007

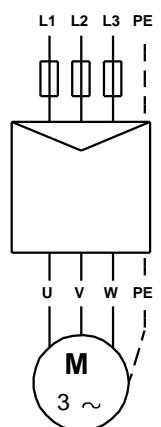
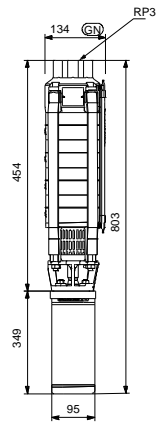
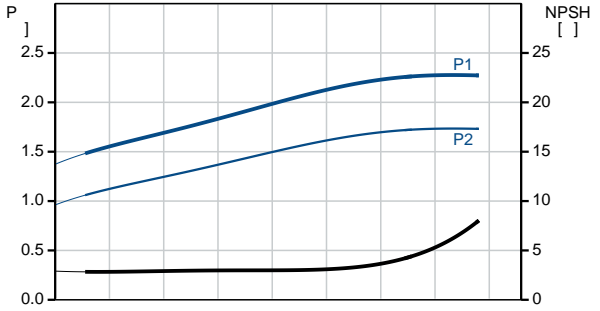
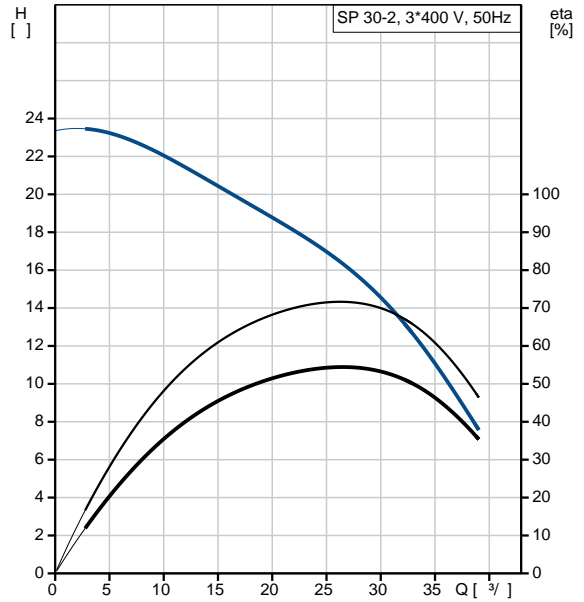

MEI :		0.50
ErP :	EuP	/ .
:		20.9
:		23.5
:		0.032 ³
Danish VVS No.:		388338020
Finnish LVI No.:		4762731
C :	DK	
:		8413702900

13A01902 SP 30-2 50

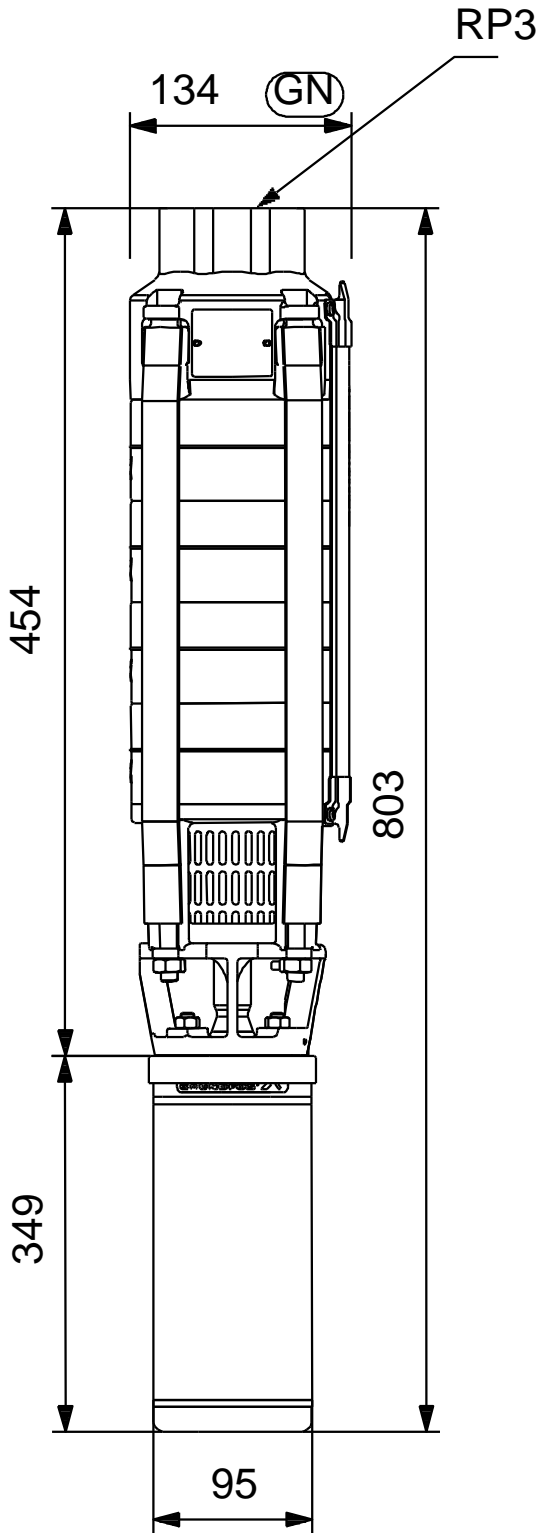

13A01902 SP 30-2 50

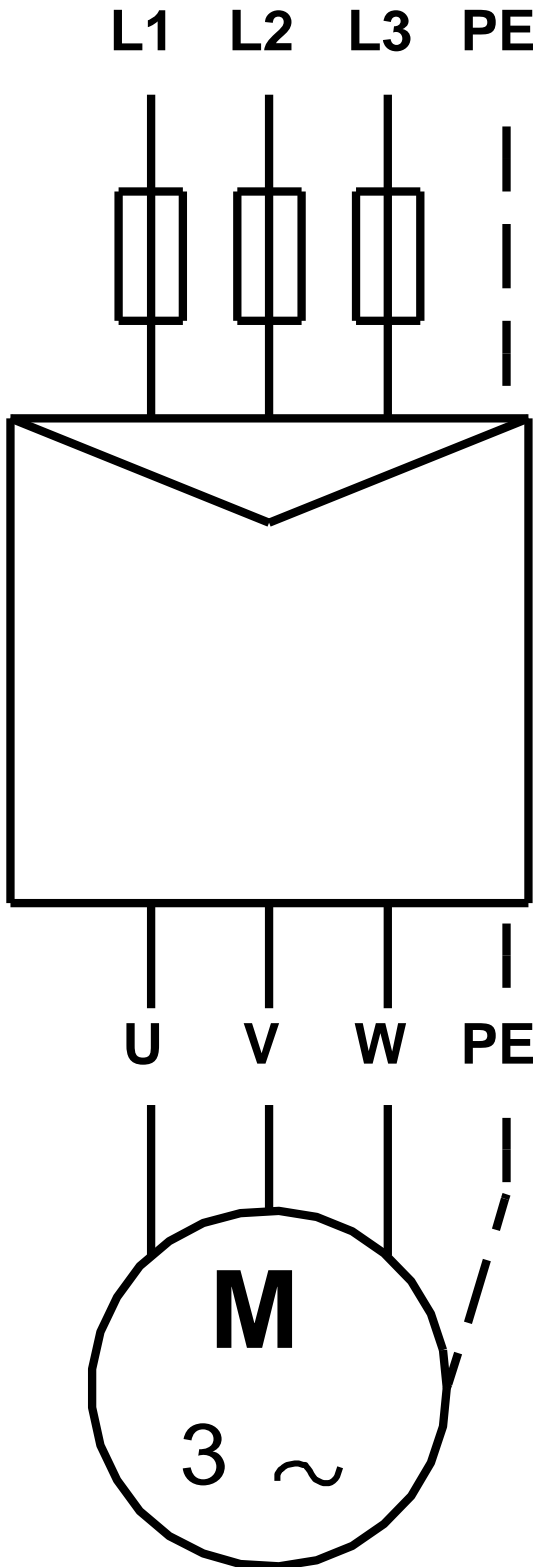

! [], .