

1 SP 30-1



: 13A01901

, EN 1.4301 (AISI 304),

MS4021.1

40 °C.

Pt1000.
(DOL).

Maximum liquid temperature: 40 °C
 . t 0,15 / : 40 °C
 : 20 °C
 : 998.2 / ³

: 2900 /

: 30 ³/₇

: LIPSEAL

: CE,EAC

- : ISO9906:2012 3B

: T40

EN 1.4301
AISI AISI 304

EN 1.4301
AISI AISI 304

DIN W.-Nr. 1.4301
AISI 304

RP3
: 4 inch

: MS402
 - P2: 1.1
 (2), : 1.1
 : 50 Hz
 : 3 x 380-400-415
 : 3.25-3.40-3.65 A
 : 480-480-470 %
 Cos - : 0.76-0.72-0.65
 : 2850-2860-2870 /
 :
 (IEC 34-5): IP68
 (IEC 85): B
 :
 : 79192005
 :
 ErP : EuP MEI : 0.50
 : 15.9 /
 : 18.5
 : 0.032 ³
 Danish VVS No.: 388338010
 Finnish LVI No.: 4762730
 C : DK
 : 8413702900

13A01901 SP 30-1 50

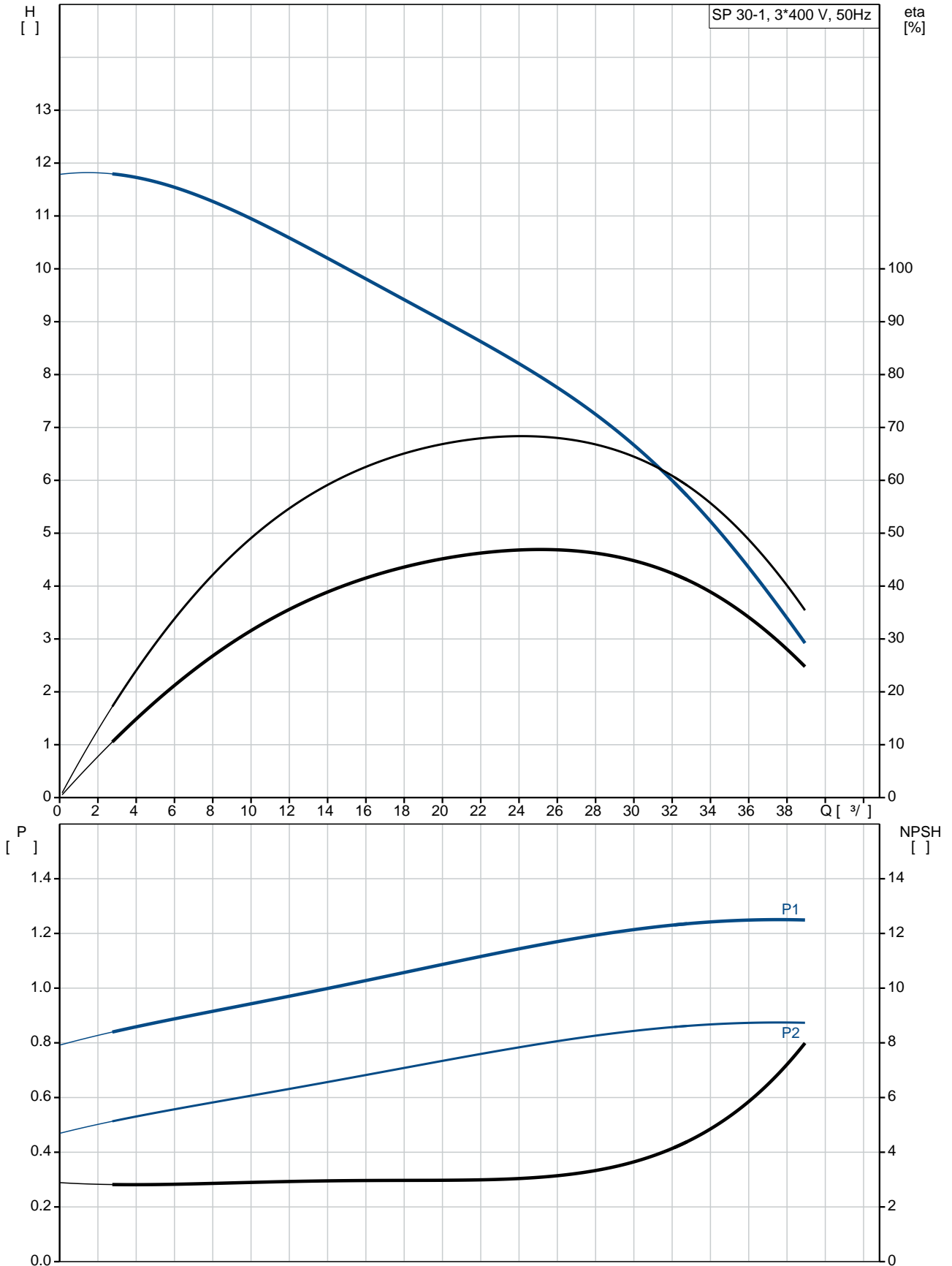

SP 30-1
 EAN : 13A01901
 5700390381035
 2900 /
 30 ^{3/}
 7
 1
 NONE
 LIPSEAL
 CE,EAC
 ISO9906:2012 3B
 B
 YES
 T40

EN 1.4301
 AISI AISI 304
 EN 1.4301
 AISI AISI 304
 DIN W.-Nr. 1.4301
 AISI 304

RP3
 4 inch

Maximum liquid temperature: 40 °C
 . t 0,15 / : 40 °C
 20 °C
 998.2 / ³

MS402
 GRUNDFOS
 - P2: 1.1
 (2), 1.1

50 Hz
 3 x 380-400-415
 3.25-3.40-3.65 A
 480-480-470 %
 Cos - : 0.76-0.72-0.65
 2850-2860-2870 /

(IEC 34-5): IP68
 (IEC 85): B

79192005

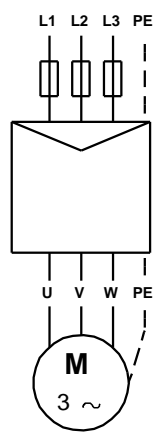
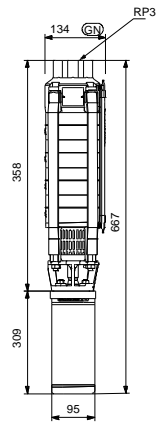
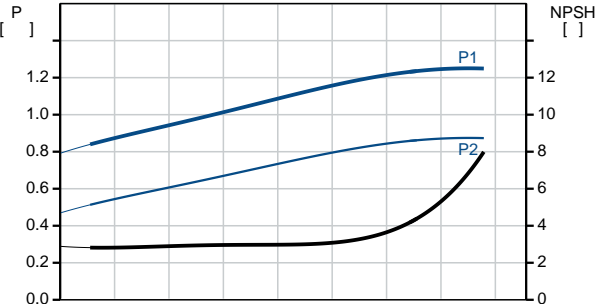
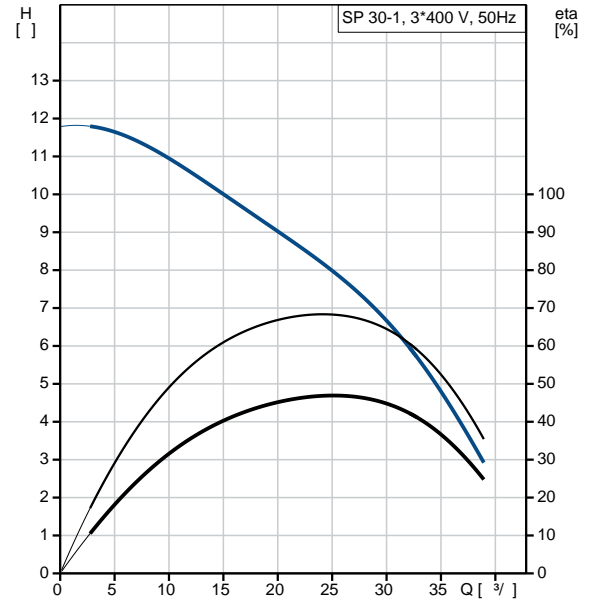

MEI :		0.50
ErP :	EuP	/ .
:		15.9
:		18.5
:		0.032 ³
Danish VVS No.:		388338010
Finnish LVI No.:		4762730
C :	DK	
:		8413702900

13A01901 SP 30-1 50

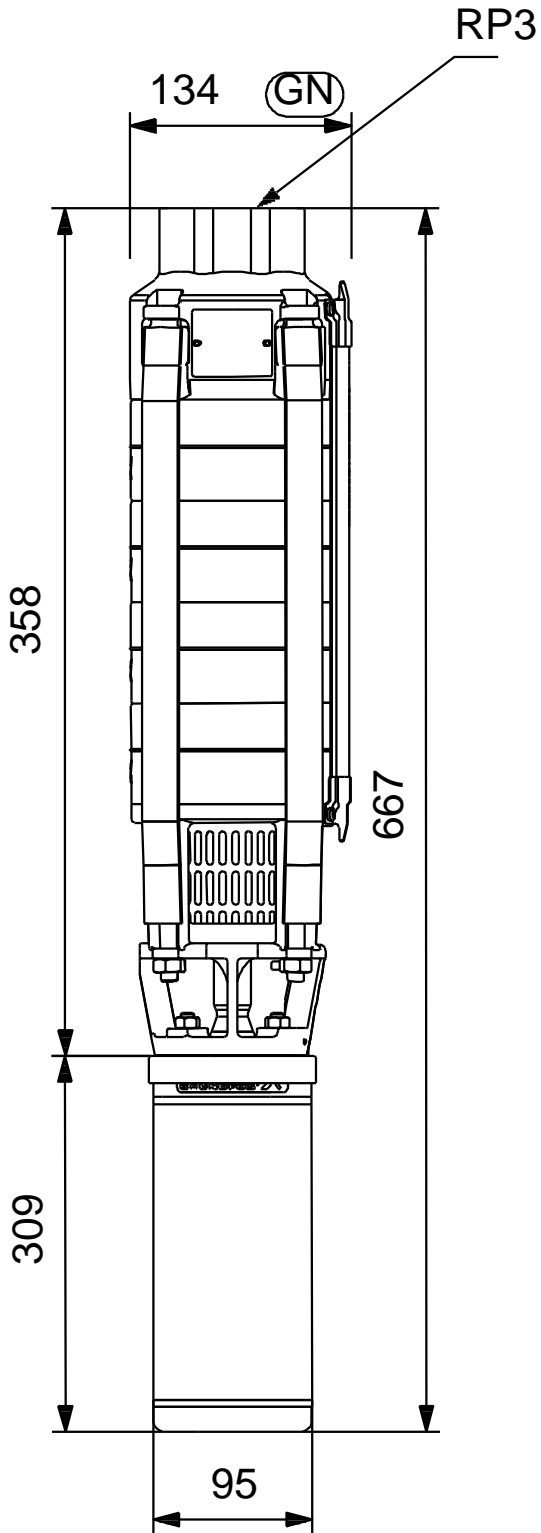

13A01901 SP 30-1 50

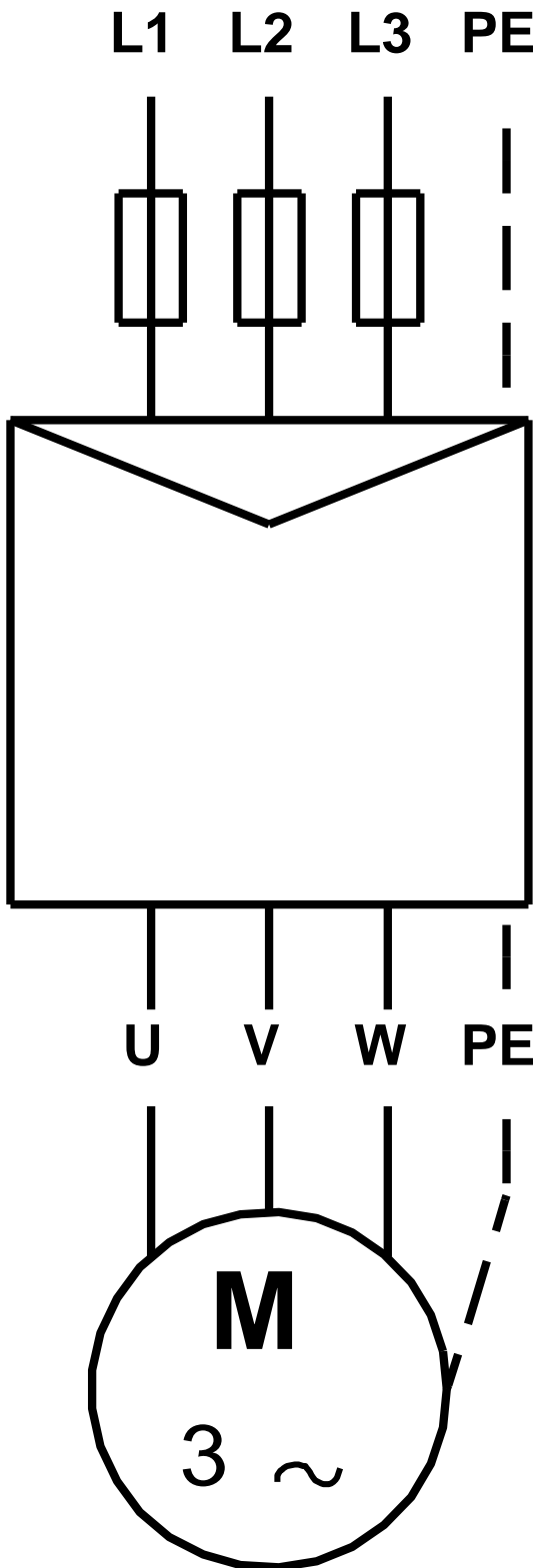

! [], .