

1 SP 17-4N



: 12C01904

, EN 1.4401 (AISI 316),
MS40002.2

40 °C.

MP204

Grundfos Tempcon,
(DOL).

Maximum liquid temperature: 40 °C
 . t 0,15 / : 40 °C
 : : 20 °C
 : 998.2 / ³

: 2900 /

: 17 ³/₃₂

: SIC/SIC
 : CE,EAC

- : ISO9906:2012 3B
 : T40

EN 1.4401
 AISI AISI 316

EN 1.4401
 AISI AISI 316

DIN W.-Nr. 1.4539
 AISI 904 L

RP2 1/2
 : 4 inch

: MS4000
 - P2: 2.2
 (2), : 2.2
 : 50 Hz
 : 3 x 380-400-415
 : 5.75-6.00-6.30 A
 : 440-450-450 %
 Cos - : 0.82-0.76-0.71
 : 2840-2860-2870 /
 :
 (IEC 34-5): IP68
 (IEC 85): F
 :
 : 79195607
 :
 ErP : MEI : 0.70
 : EuP /
 : 25.3
 : 27.9
 : 0.032 ³
 C : DK
 : 8413702900

12C01904 SP 17-4N 50

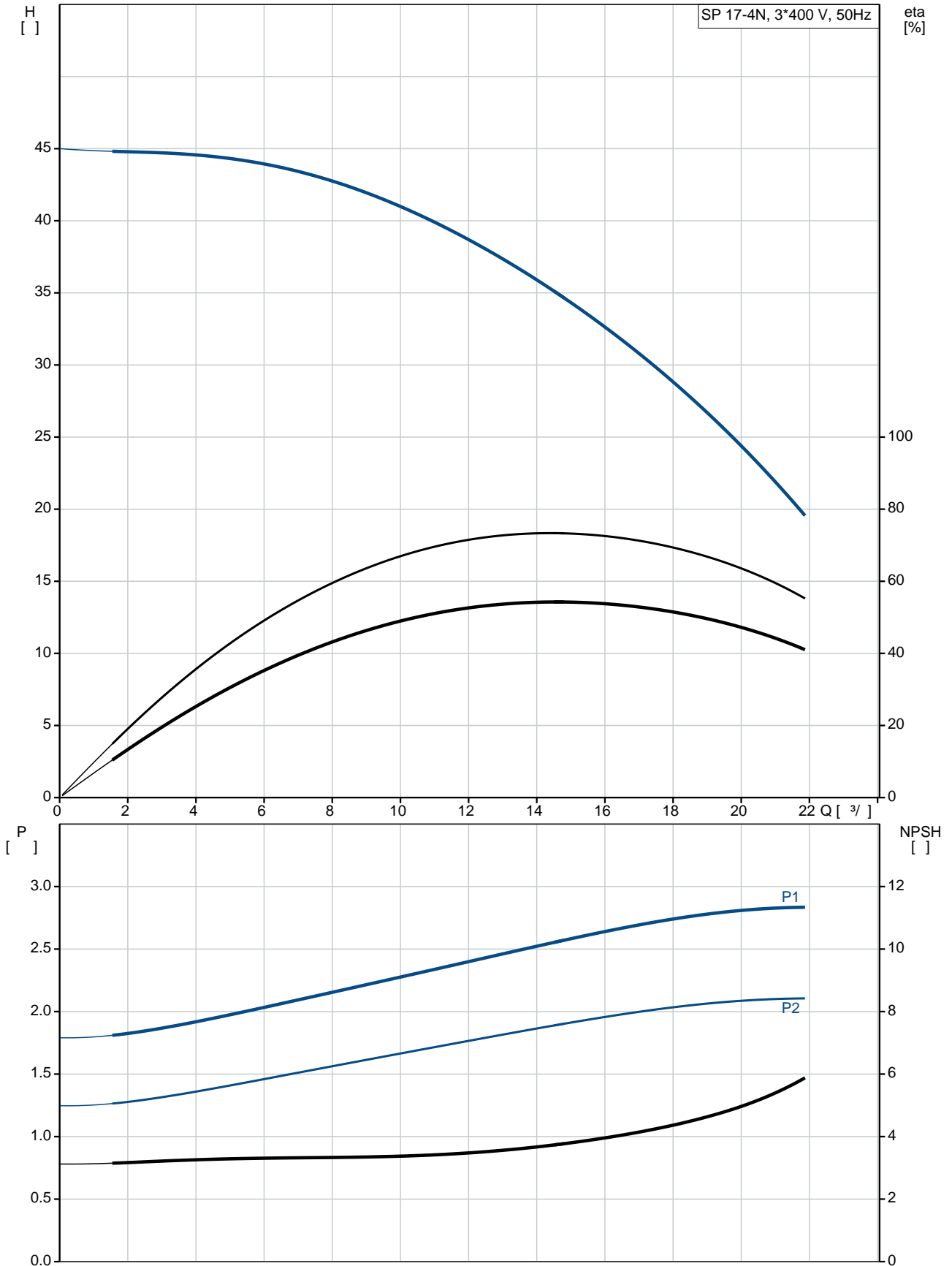

SP 17-4N
 12C01904
 EAN : 5700391324666

2900 /
 17 ³/₄
 32
 4
 NONE
 SIC/SIC
 CE,EAC
 ISO9906:2012 3B
 B
 YES
 T40

EN 1.4401
 AISI AISI 316
 EN 1.4401
 AISI AISI 316
 DIN W.-Nr. 1.4539
 AISI 904 L

RP2 1/2
 4 inch

Maximum liquid temperature: 40 °C
 . t 0,15 / : 40 °C
 20 °C
 998.2 / ³

MS4000
 GRUNDFOS
 - P2: 2.2
 (2), 2.2

50 Hz
 3 x 380-400-415
 5.75-6.00-6.30 A
 440-450-450 %
 Cos - : 0.82-0.76-0.71
 2840-2860-2870 /

(IEC 34-5): IP68
 (IEC 85): F

79195607

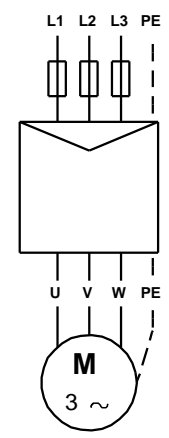
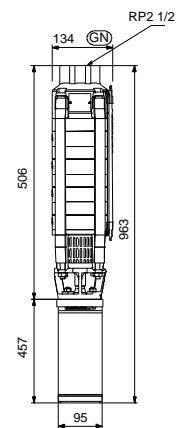
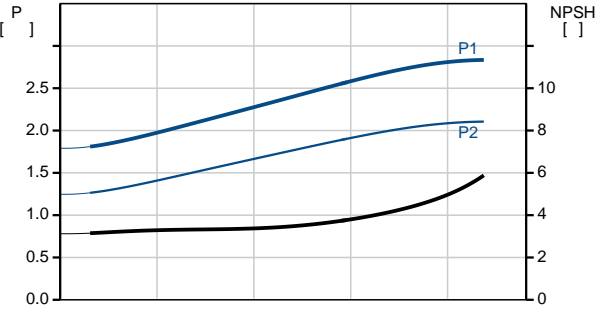
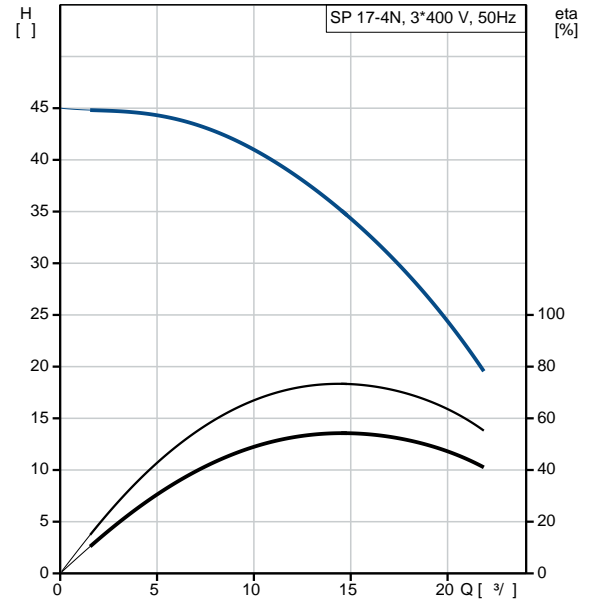

		MEI :	0.70
ErP	:	EuP	/ .
	:		25.3
	:		27.9
	:		0.032 ³
C	:	DK	
	:		8413702900

12C01904 SP 17-4N 50

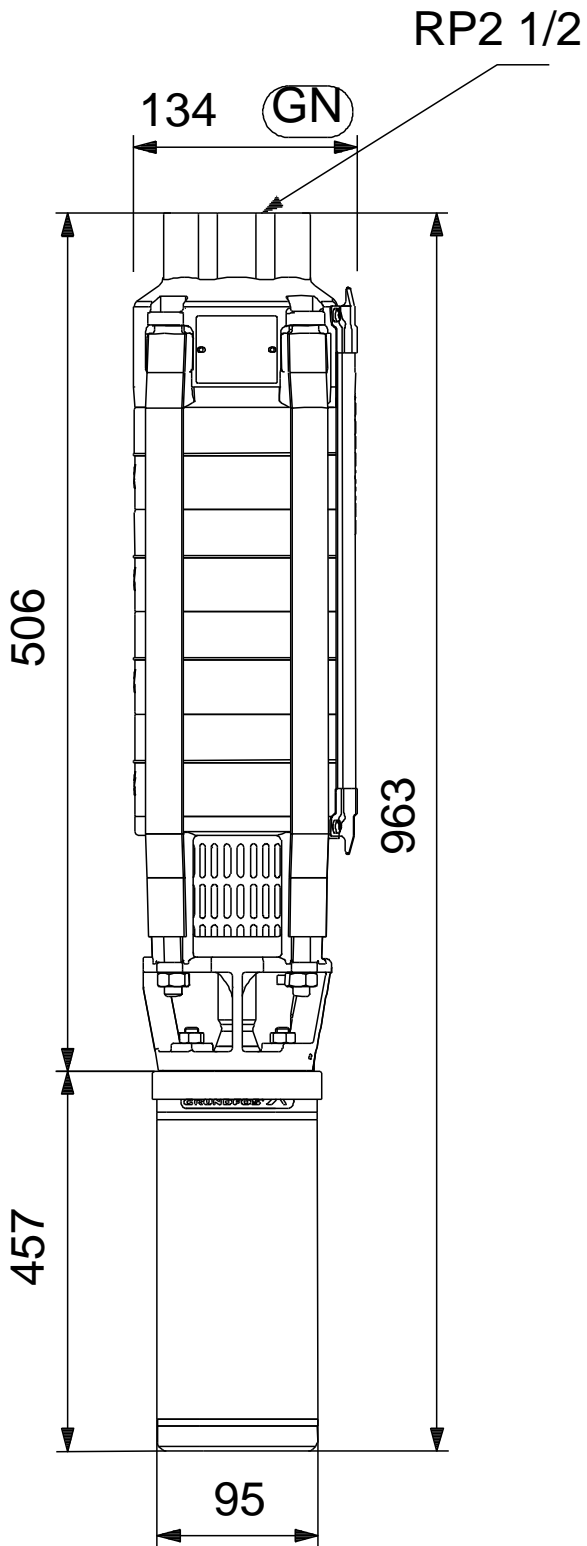

12C01904 SP 17-4N 50

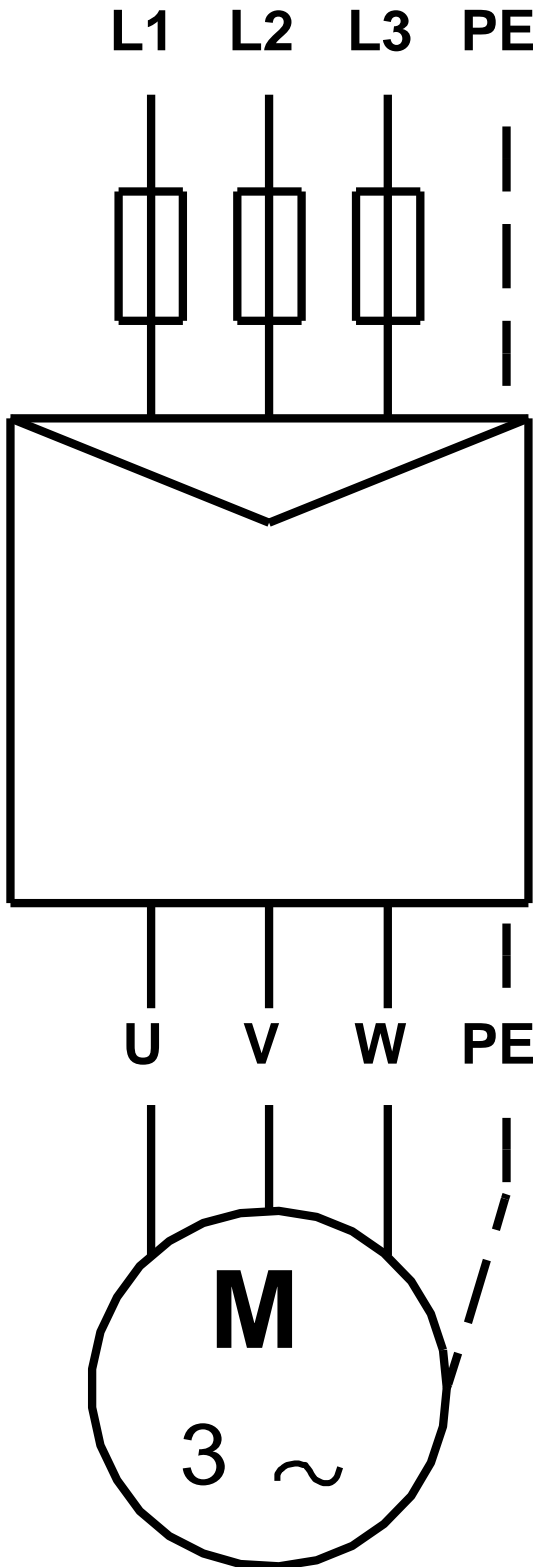

! [], .