

1 SP 17-2N



: 12C01902

, EN 1.4401 (AISI 316),
MS40001.1

40 °C.

MP204

Grundfos Tempcon,
(DOL).

Maximum liquid temperature: 40 °C
 . t 0,15 / : 40 °C
 : : 20 °C
 : 998.2 / ³

: 2900 /

: 17 ³/₁₅

: SIC/SIC
 : CE,EAC

- : ISO9906:2012 3B
 : T40

EN 1.4401
 AISI AISI 316

EN 1.4401
 AISI AISI 316

DIN W.-Nr. 1.4539
 AISI 904 L

RP2 1/2
 : 4 inch

: MS4000
 - P2: 1.1
 (2), : 1.1
 : 50 Hz
 : 3 x 380-400-415
 : 2.80-2.75-2.75 A
 : 440-480-500 %
 Cos - : 0.85-0.82-0.78
 : 2850-2870-2880 /
 :
 (IEC 34-5): IP68
 (IEC 85): F
 :
 : 79195605
 :
 ErP : MEI : 0.70
 : EuP / .
 : 20.6
 : 23.1
 : 0.032 ³
 Danish VVS No.: 388366020
 C : DK
 : 8413702900

12C01902 SP 17-2N 50

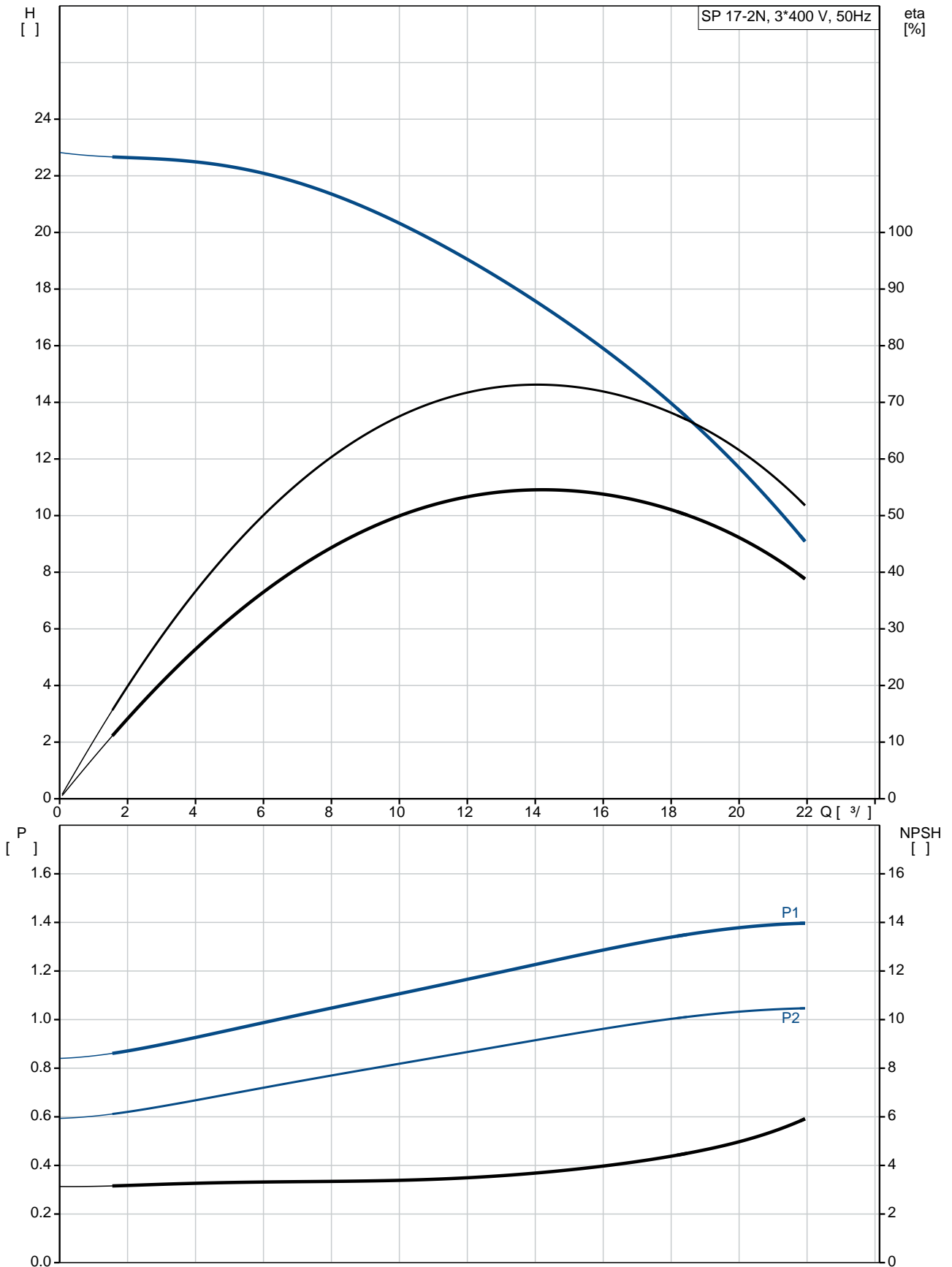

SP 17-2N
 12C01902
 EAN : 5700391324574

2900 /
 17 ³/_l
 15
 2
 NONE
 SIC/SIC
 CE,EAC
 ISO9906:2012 3B
 B
 YES
 T40

EN 1.4401
 AISI AISI 316

EN 1.4401
 AISI AISI 316

DIN W.-Nr. 1.4539
 AISI 904 L

RP2 1/2
 4 inch

Maximum liquid temperature: 40 °C
 . t 0,15 / : 40 °C
 20 °C
 998.2 / ³

MS4000
 GRUNDFOS
 - P2: 1.1
 (2), 1.1

50 Hz
 3 x 380-400-415
 2.80-2.75-2.75 A
 440-480-500 %
 Cos - : 0.85-0.82-0.78
 2850-2870-2880 /

(IEC 34-5): IP68
 (IEC 85): F

79195605

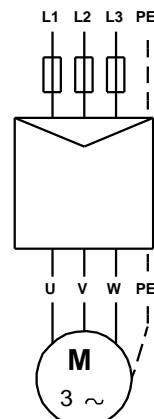
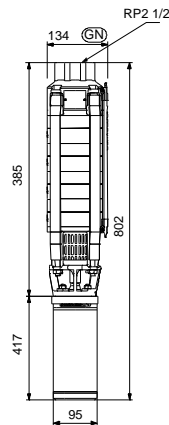
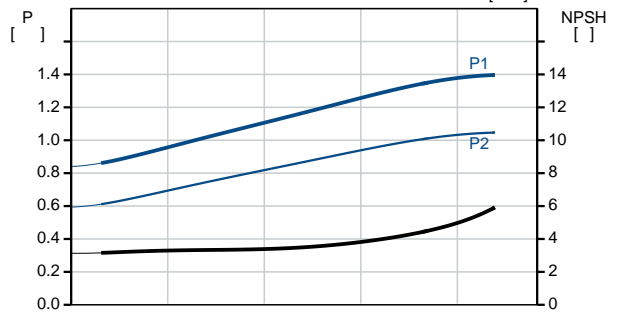
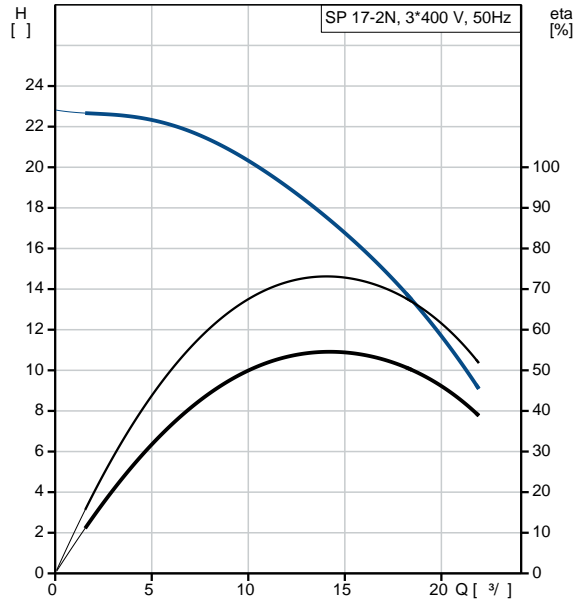

MEI :	0.70
ErP :	EuP / .
:	20.6
:	23.1
:	0.032 ³
Danish VVS No.:	388366020
C :	DK
:	8413702900

12C01902 SP 17-2N 50

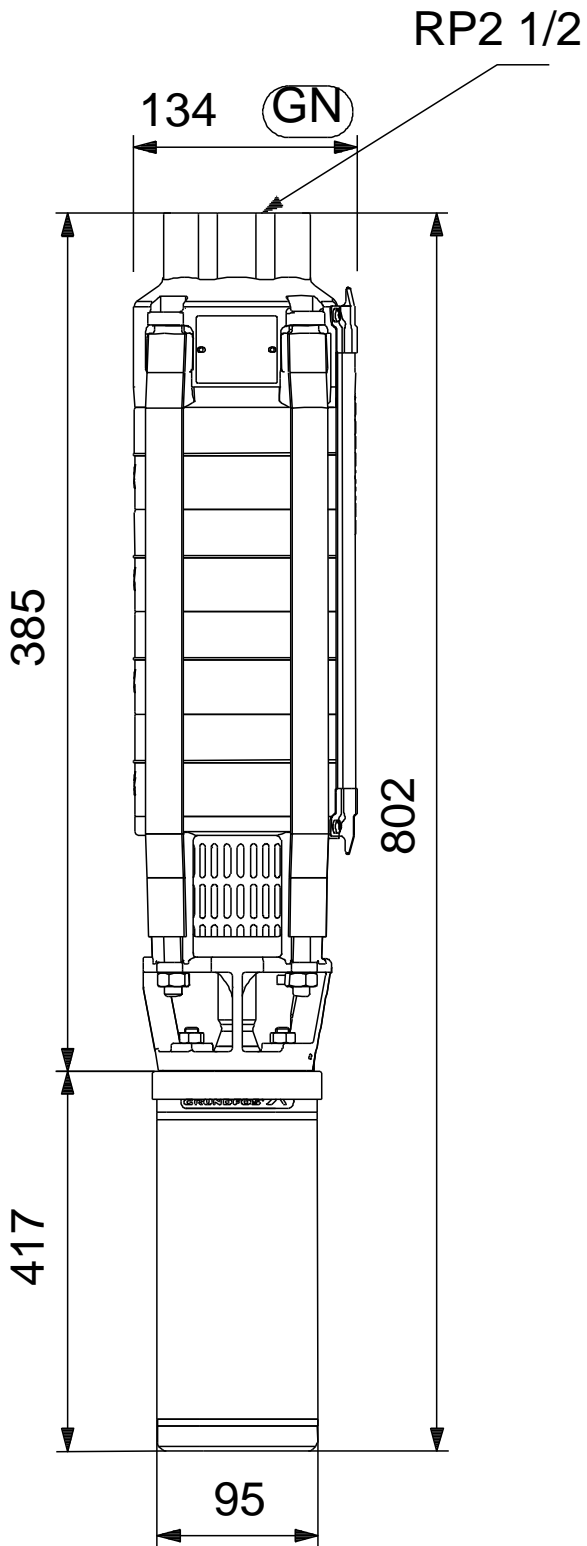

12C01902 SP 17-2N 50

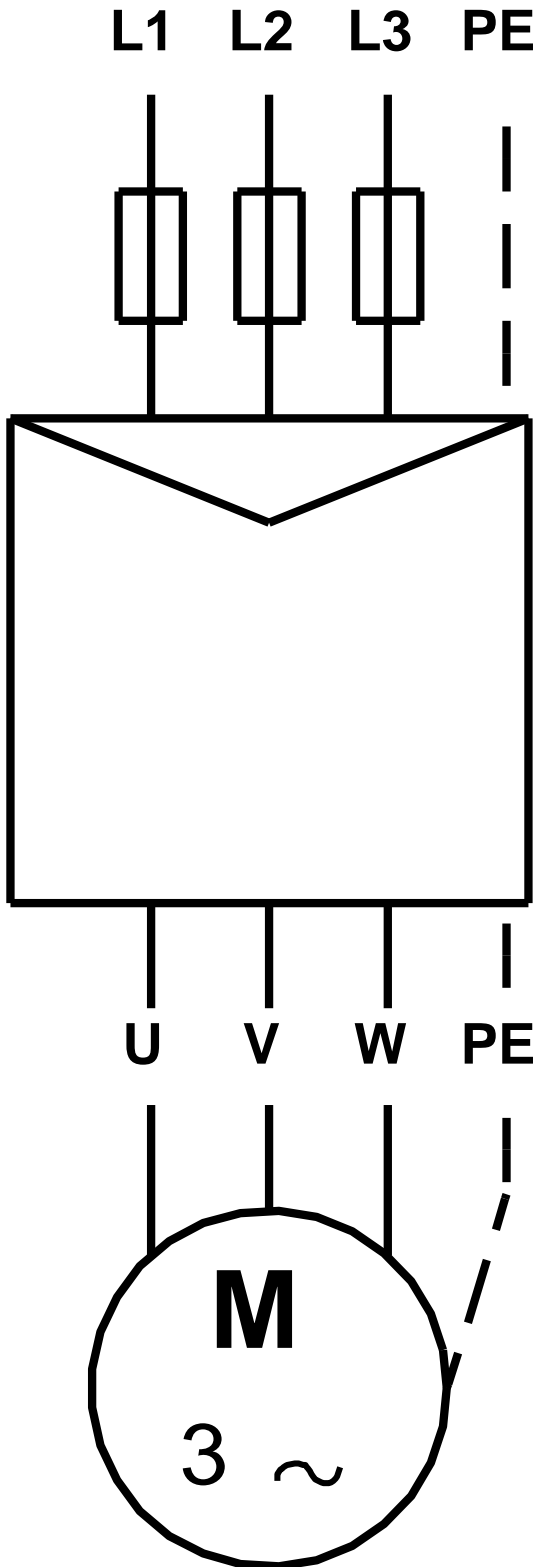

! [], .