

1 SP 17-8



: 12A01908

, EN 1.4301 (AISI 304),

MS40005.5

40 °C.

MP204

Grundfos Tempcon,
(DOL).

Maximum liquid temperature: 40 °C
 . t 0,15 / : 40 °C
 : 20 °C
 : 998.2 / ³

: 2900 /

17 ³/₁₆
 65

: HM/CER
 : CE,EAC
 - : ISO9906:2012 3B
 : T40

EN 1.4301
 AISI AISI 304

EN 1.4301
 AISI AISI 304

DIN W.-Nr. 1.4301
 AISI 304

RP2 1/2
 : 4 inch

: MS4000
 - P2: 5.5
 (2), : 5.5
 : 50 Hz
 : 3 x 380-400-415
 : 13.0-13.0-13.4 A
 : 480-530-550 %
 Cos - : 0.85-0.81-0.76
 : 2850-2860-2870 /
 :
 (IEC 34-5): IP68
 (IEC 85): F
 :
 : 79195511
 :
 ErP : MEI : 0.70
 : EuP /
 : 41.8
 : 67
 : 0.2 ³
 Danish VVS No.: 388336080
 Finnish LVI No.: 4762721
 C : DK
 : 8413702900

12A01908 SP 17-8 50

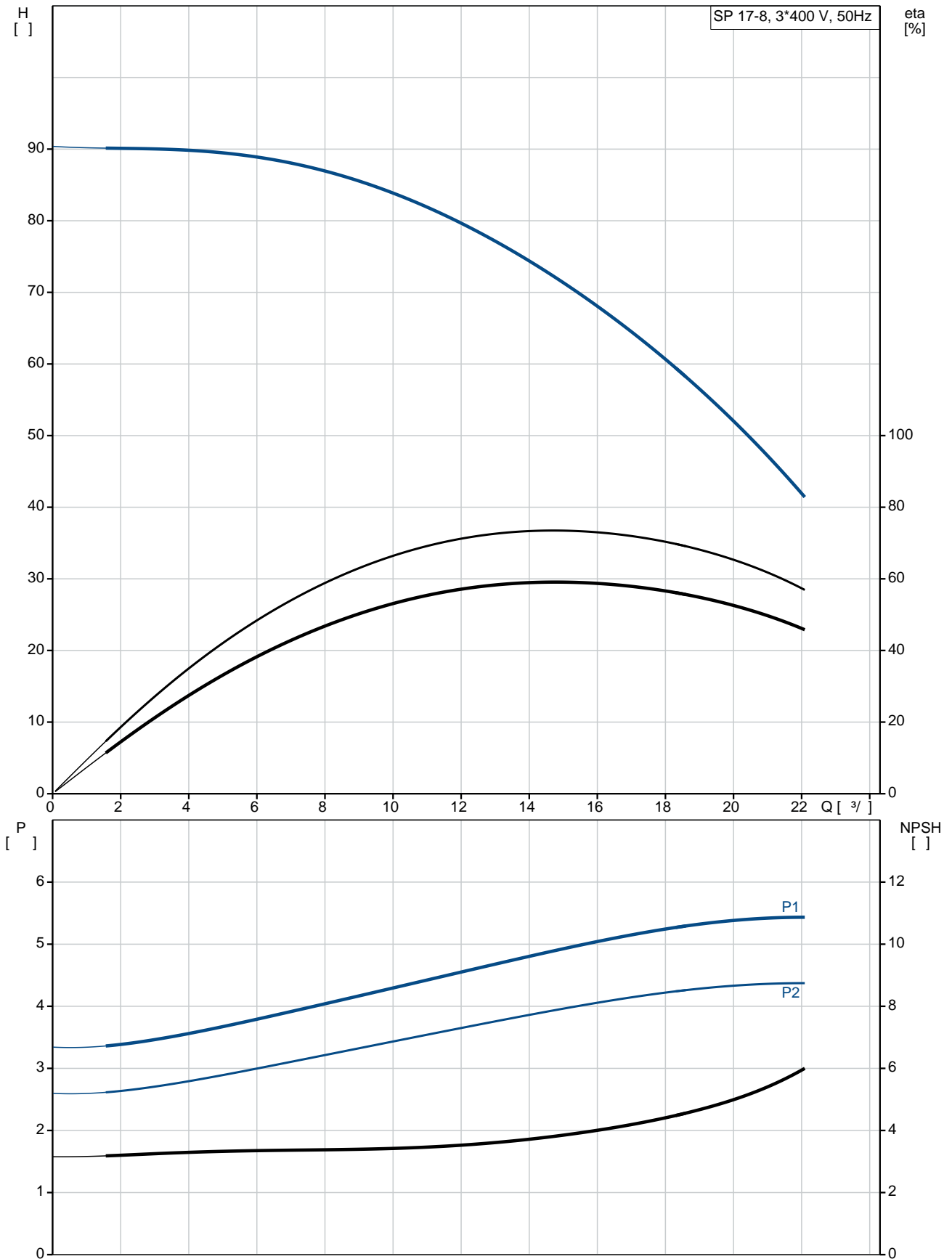

SP 17-8
 EAN : 12A01908
 5700391131141

2900 /
 17 ³/_l
 65
 8
 NONE
 HM/CER
 CE,EAC
 ISO9906:2012 3B
 B
 YES
 T40

EN 1.4301
 AISI AISI 304
 EN 1.4301
 AISI AISI 304
 DIN W.-Nr. 1.4301
 AISI 304

RP2 1/2
 4 inch

Maximum liquid temperature: 40 °C
 . t 0,15 / : 40 °C
 20 °C
 998.2 / ³

MS4000
 GRUNDFOS
 - P2: 5.5
 (2), 5.5

50 Hz
 3 x 380-400-415
 13.0-13.0-13.4 A
 480-530-550 %
 Cos - : 0.85-0.81-0.76
 2850-2860-2870 /

(IEC 34-5): IP68
 (IEC 85): F

79195511

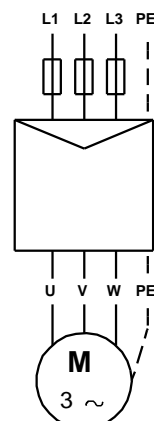
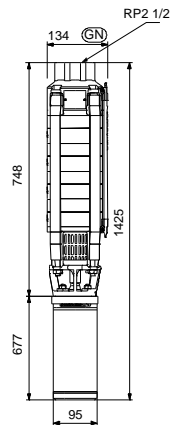
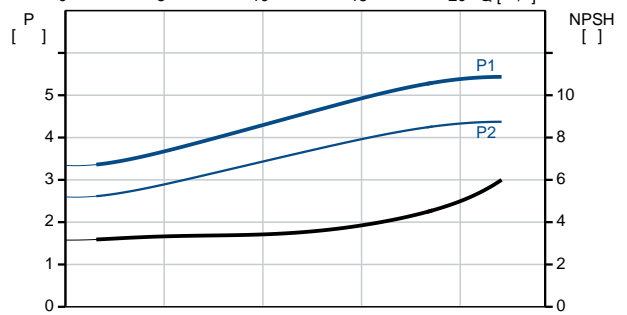
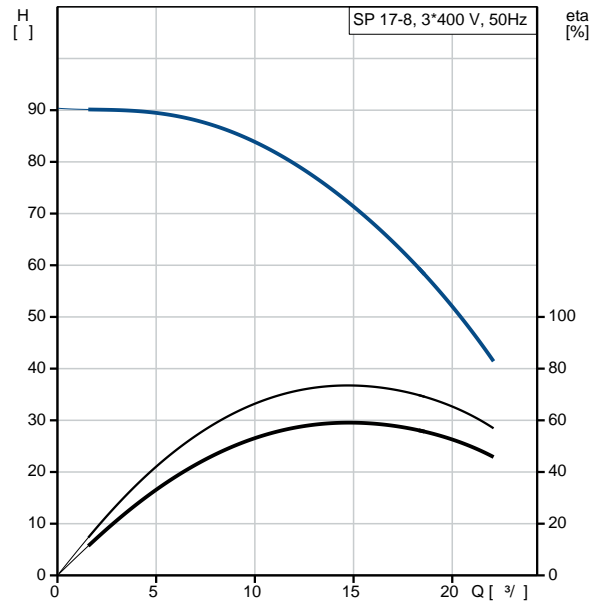

MEI :	0.70
ErP :	EuP / .
:	41.8
:	67
:	0.2 ³
Danish VVS No.:	388336080
Finnish LVI No.:	4762721
C :	DK
:	8413702900

12A01908 SP 17-8 50

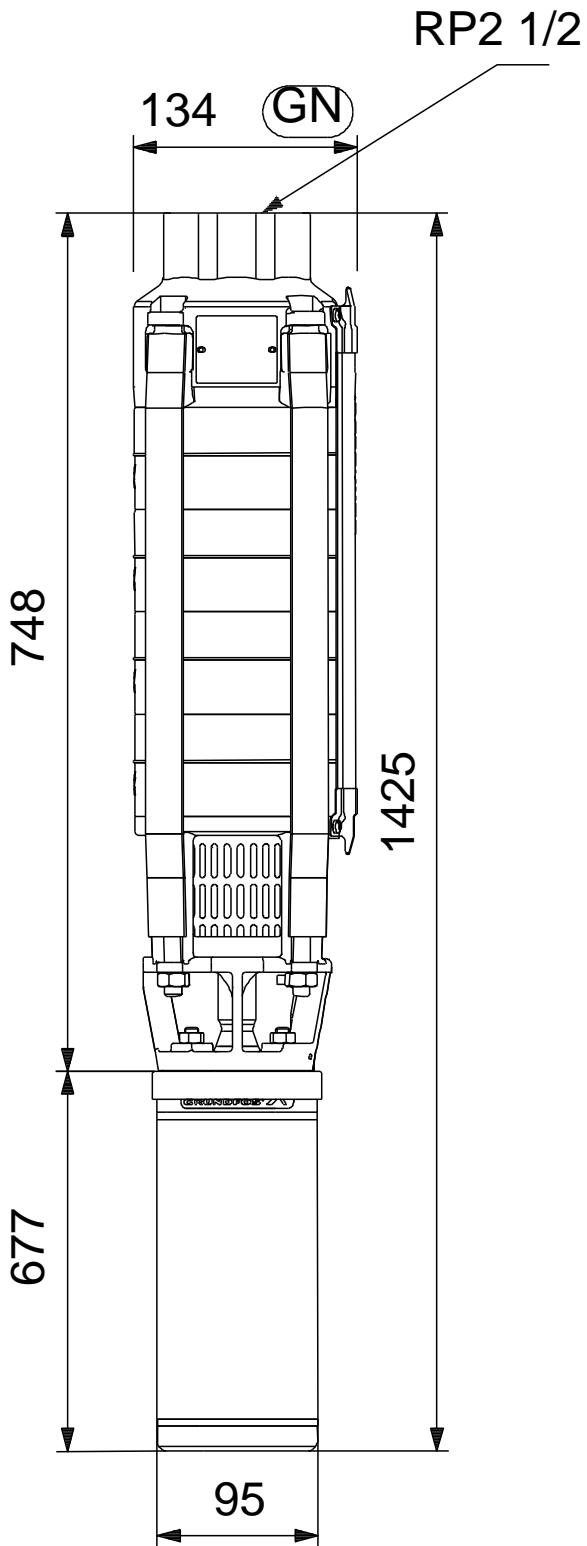

12A01908 SP 17-8 50

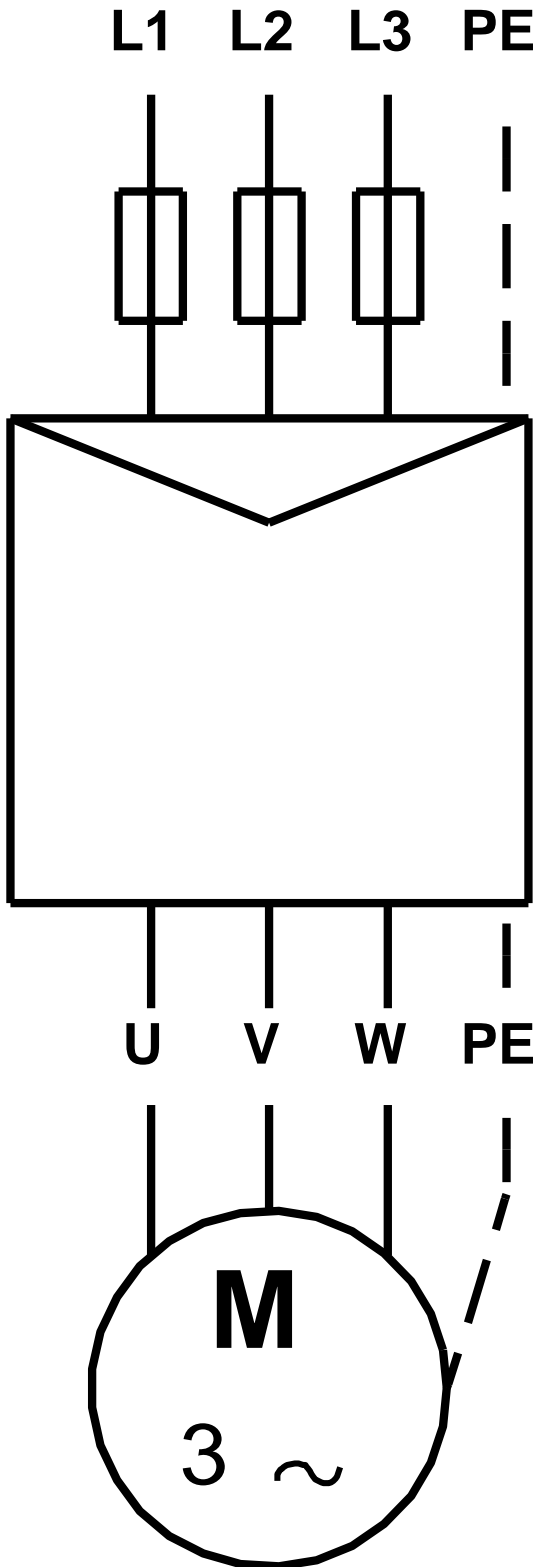

!

[],