

1 SP 17-1



: 12A01901

, EN 1.4301 (AISI 304),

MS4020.55

40 °C.

Pt1000.
(DOL).

Maximum liquid temperature: 40 °C
 . t 0,15 / : 40 °C
 : 20 °C
 : 998.2 / ³

: 2900 /

: 17 ³/₇

: LIPSEAL

: CE,EAC

- : ISO9906:2012 3B

: T40

EN 1.4301
AISI AISI 304

EN 1.4301
AISI AISI 304

DIN W.-Nr. 1.4301
AISI 304

RP2 1/2
: 4 inch

: MS402
 - P2: 0.55
 (2), : 0.55
 : 50 Hz
 : 3 x 380-400-415
 : 2.00-2.20-2.35 A
 : 470-480-470 %
 Cos - : 0.70-0.64-0.60
 : 2850-2860-2870 /
 :
 (IEC 34-5): IP68
 (IEC 85): B
 :
 : 79192003
 :
 ErP : MEI : 0.70
 : EuP /
 : 12.1
 : 14.7
 : 0.032 ³
 Danish VVS No.: 388336010
 Finnish LVI No.: 4762714
 C : DK
 : 8413702900

12A01901 SP 17-1 50

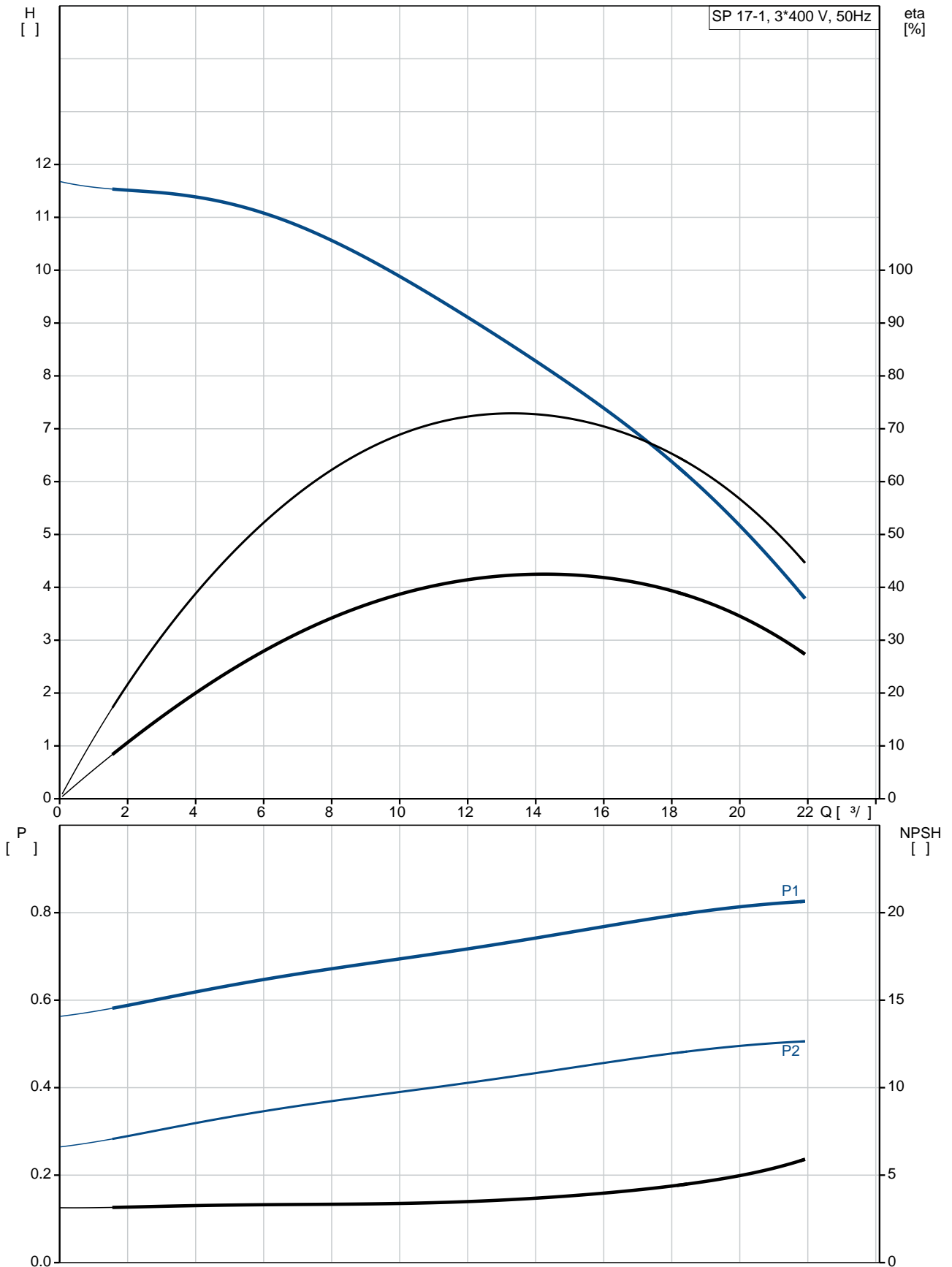

SP 17-1
 12A01901
 EAN : 5700391130854

2900 /
 17 ³/_l
 7
 1
 NONE
 LIPSEAL
 CE,EAC
 ISO9906:2012 3B
 B
 YES
 T40

EN 1.4301
 AISI AISI 304
 EN 1.4301
 AISI AISI 304
 DIN W.-Nr. 1.4301
 AISI 304

RP2 1/2
 4 inch

Maximum liquid temperature: 40 °C
 . t 0,15 / : 40 °C
 20 °C
 998.2 / ³

MS402
 GRUNDFOS
 - P2: 0.55
 (2), 0.55

50 Hz
 3 x 380-400-415
 2.00-2.20-2.35 A
 470-480-470 %
 Cos - : 0.70-0.64-0.60
 2850-2860-2870 /

(IEC 34-5): IP68
 (IEC 85): B

79192003

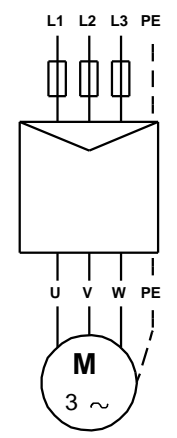
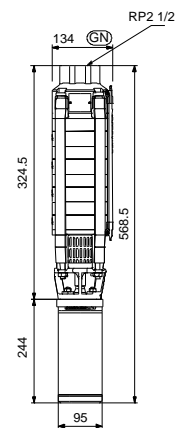
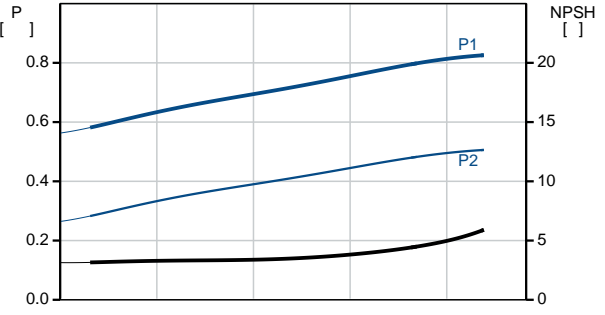
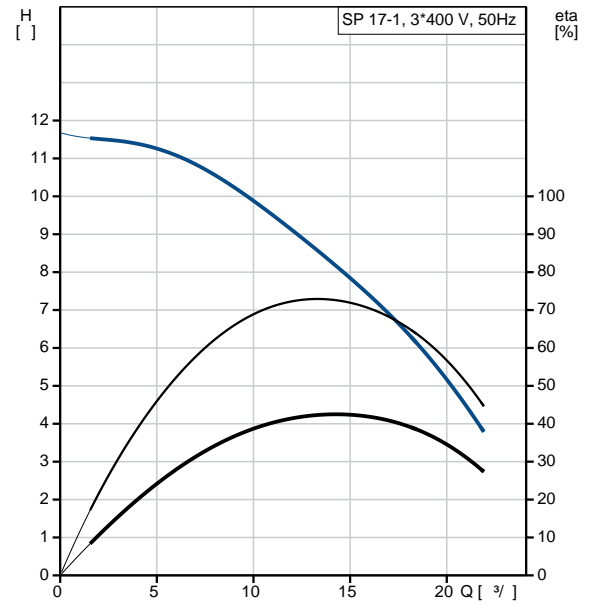

MEI :	0.70
ErP :	EuP / .
:	12.1
:	14.7
:	0.032 ³
Danish VVS No.:	388336010
Finnish LVI No.:	4762714
C :	DK
:	8413702900

12A01901 SP 17-1 50

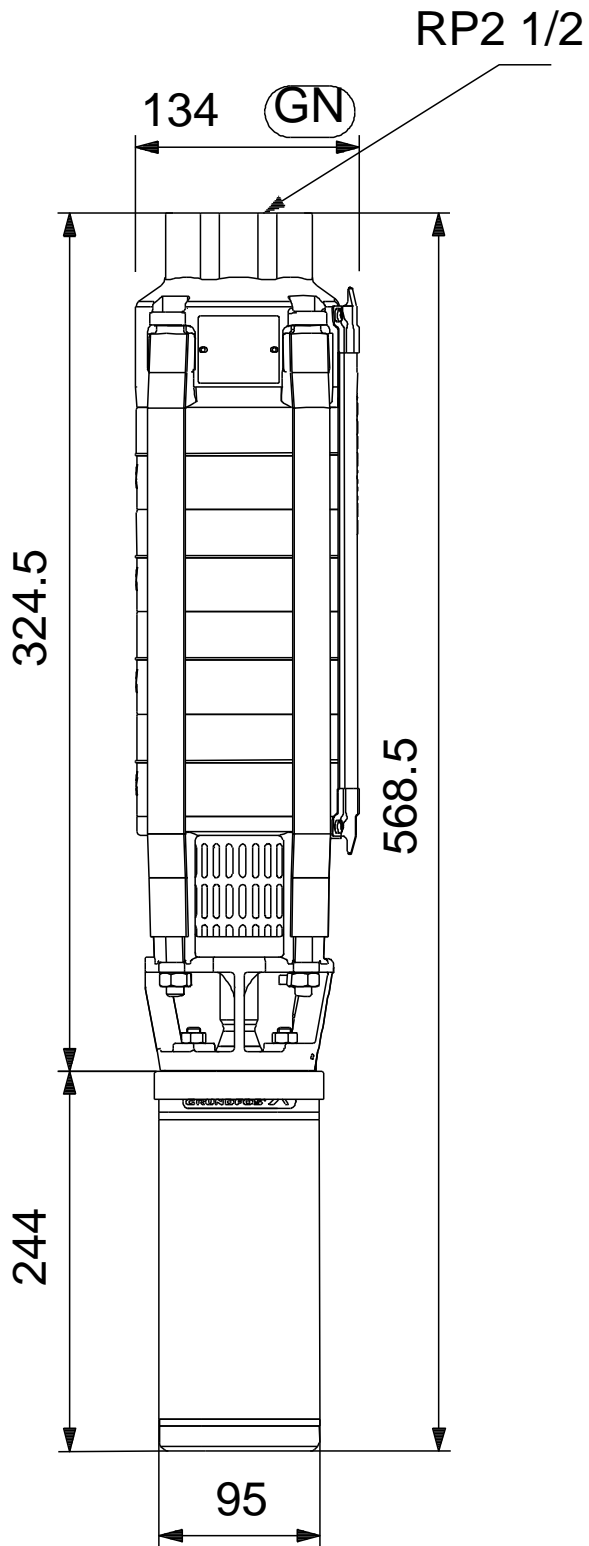

12A01901 SP 17-1 50

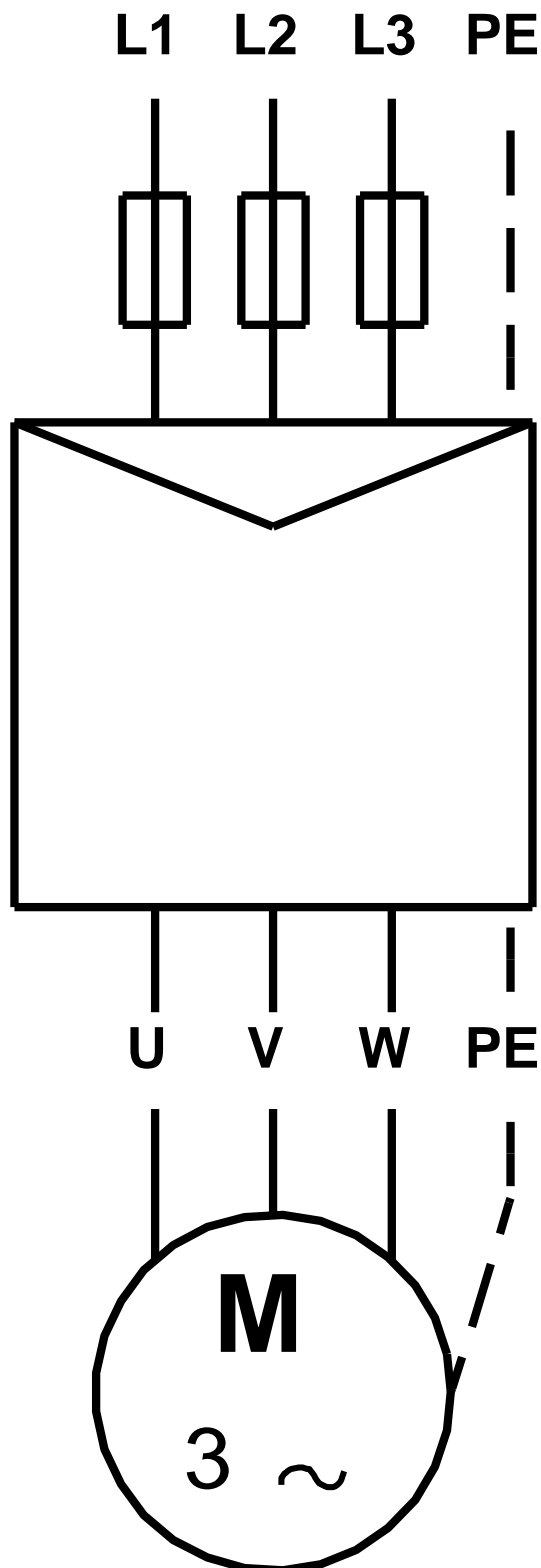

! [], .