

1 SP 1A-50



: 08101K50

, EN 1.4301 (AISI 304),

MS4021.5

40 °C.

Pt1000.
(DOL).

Maximum liquid temperature: 40 °C
 . t 0,15 / : 40 °C
 : 998.2 / ³ : 20 °C

: 2900 /

: 1 ³/₁₇₅
 : LIPSEAL
 : CE,EAC
 - : ISO9906:2012 3B
 : T40
 : CYLINDRICAL

EN 1.4301
 AISI AISI 304

EN 1.4301
 AISI AISI 304

DIN W.-Nr. 1.4301
 AISI 304

:
 : Rp1 1/4
 : 4 inch
 :
 : MS402
 - P2: 1.5
 (2), : 1.5
 : 50 Hz
 : 3 x 380-400-415
 : 4.10-4.20-4.40 A
 : 490-500-500 %
 Cos - : 0.80-0.75-0.70
 : 2850-2860-2870 /
 :
 (IEC 34-5): IP68
 (IEC 85): B
 :
 : 79192006
 :
 MEI : 0.70
 ErP : EuP /
 : 21.3
 : 34.1
 : 68³
 Danish VVS No.: 388311500
 Swedish RSK No.: 5850292
 Norwegian NRF no.: 9040808
 C : DK
 : 8413702900

08101K50 SP 1A-50 50

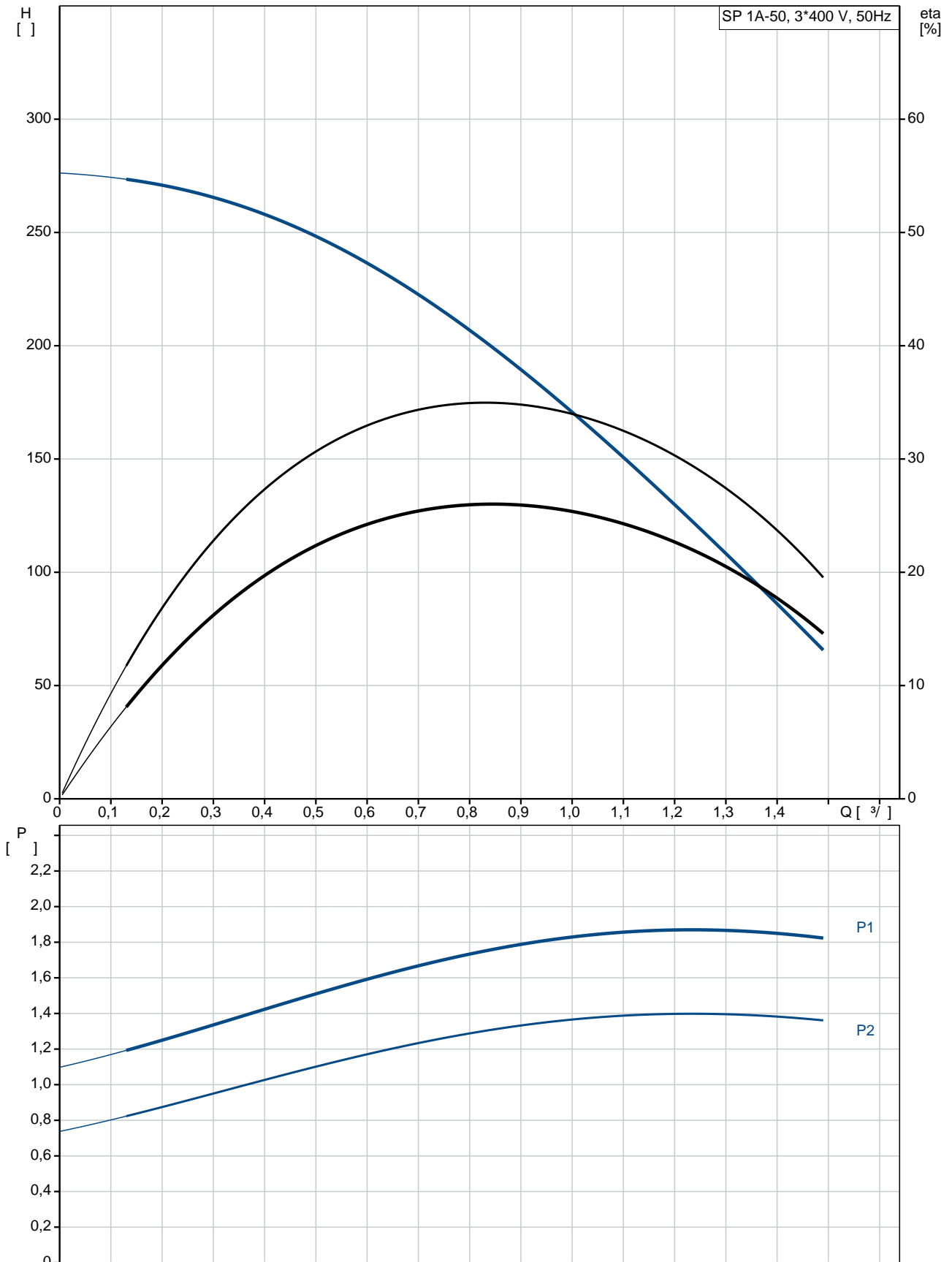

SP 1A-50
 EAN : 08101K50
 5708601051265

2900 /
 1 3/
 175
 50
 NONE
 LIPSEAL
 CE,EAC
 ISO9906:2012 3B
 A
 YES
 T40
 CYLINDRICAL

EN 1.4301
 AISI AISI 304
 EN 1.4301
 AISI AISI 304
 DIN W.-Nr. 1.4301
 AISI 304

Rp1 1/4
 4 inch

Maximum liquid temperature: 40 °C
 . t 0,15 / : 40 °C
 20 °C
 998.2 / 3

MS402
 GRUNDFOS
 - P2: 1.5
 (2), 1.5

50 Hz
 3 x 380-400-415
 4.10-4.20-4.40 A
 490-500-500 %
 Cos - : 0.80-0.75-0.70
 2850-2860-2870 /

(IEC 34-5): IP68
 (IEC 85): B

79192006

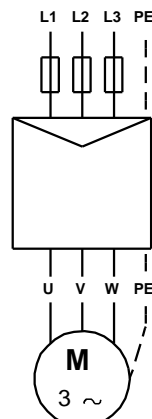
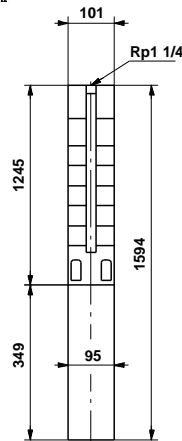
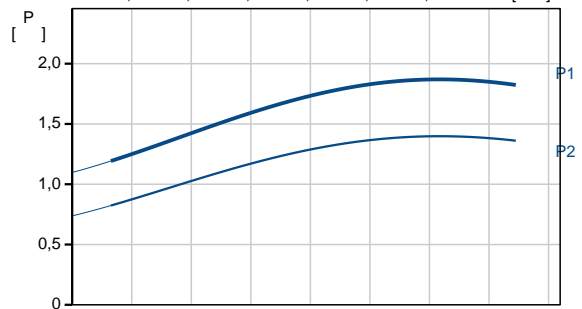
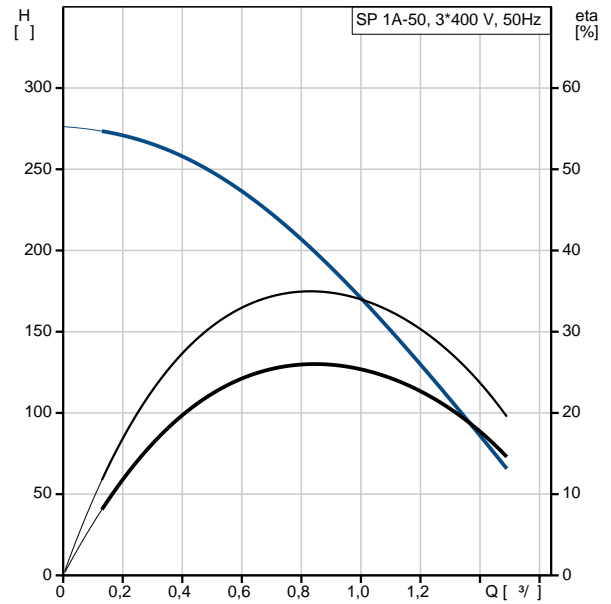

MEI :		0.70
ErP :	EuP	/ .
:		21.3
:		34.1
:		68 ³
Danish VVS No.:		388311500
Swedish RSK No.:		5850292
Norwegian NRF no.:		9040808
C :	DK	
:		8413702900

08101K50 SP 1A-50 50

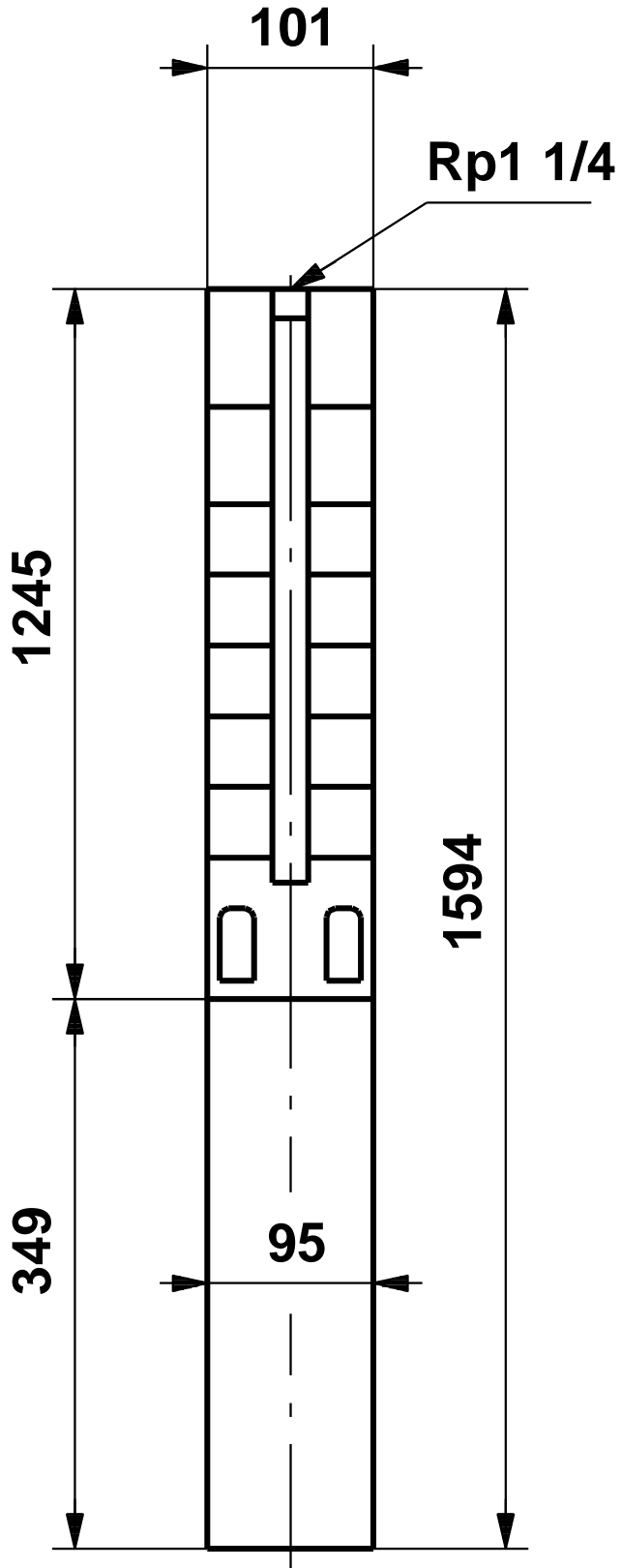

08101K50 SP 1A-50 50

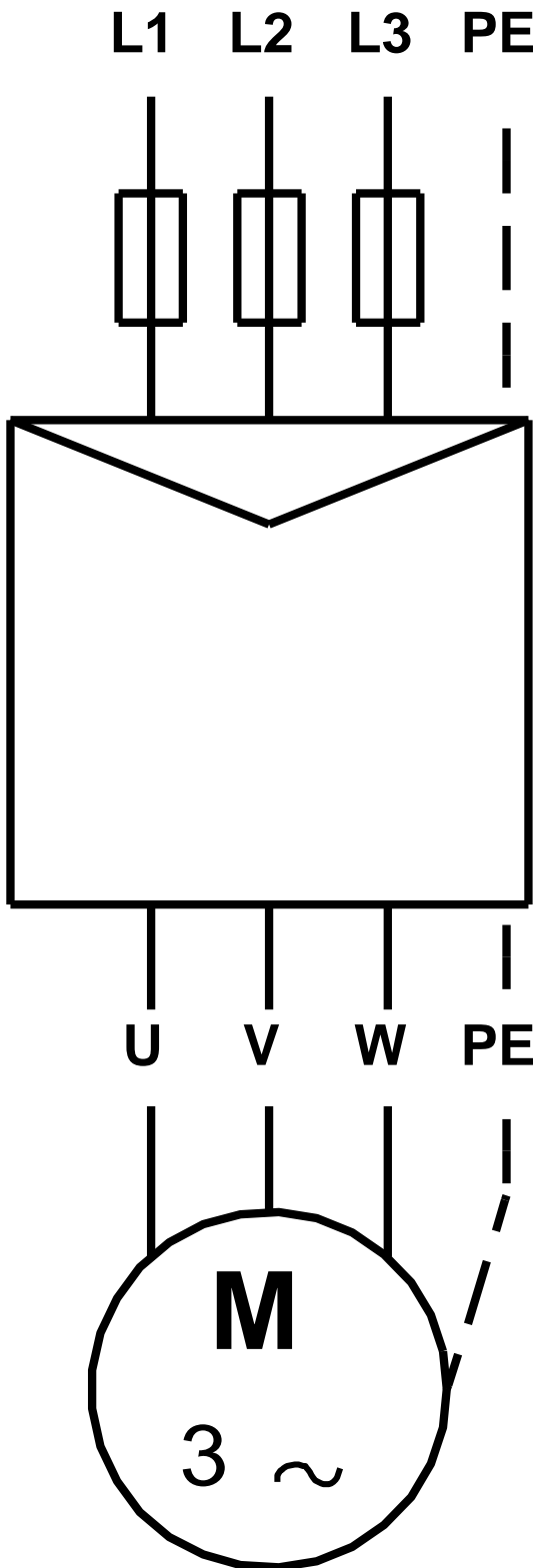

! [], .