

1 SP 1A-36



: 08101K36

, EN 1.4301 (AISI 304),

MS4021.1

40 °C.

Pt1000.  
(DOL).

Maximum liquid temperature: 40 °C  
 . t 0,15 / : 40 °C  
 : 998.2 / <sup>3</sup> : 20 °C

: 2900 /

: 1 <sup>3</sup>/<sub>126</sub>  
 : LIPSEAL  
 : CE,EAC  
 - : ISO9906:2012 3B  
 : T40  
 : CYLINDRICAL

EN 1.4301  
 AISI AISI 304

EN 1.4301  
 AISI AISI 304

DIN W.-Nr. 1.4301  
 AISI 304

:  
 : Rp1 1/4  
 : 4 inch  
 :  
 : MS402  
 - P2: 1.1  
 ( 2), : 1.1  
 : 50 Hz  
 : 3 x 380-400-415  
 : 3.25-3.40-3.65 A  
 : 480-480-470 %  
 Cos - : 0.76-0.72-0.65  
 : 2850-2860-2870 /  
 :  
 (IEC 34-5): IP68  
 (IEC 85): B  
 :  
 : 79192005  
 :  
 MEI : 0.70  
 ErP : EuP / .  
 : 17.6  
 : 25  
 : 21.7 <sup>3</sup>  
 Danish VVS No.: 388311360  
 Swedish RSK No.: 5850290  
 Norwegian NRF no.: 9040806  
 C : DK  
 : 8413702900

## 08101K36 SP 1A-36 50

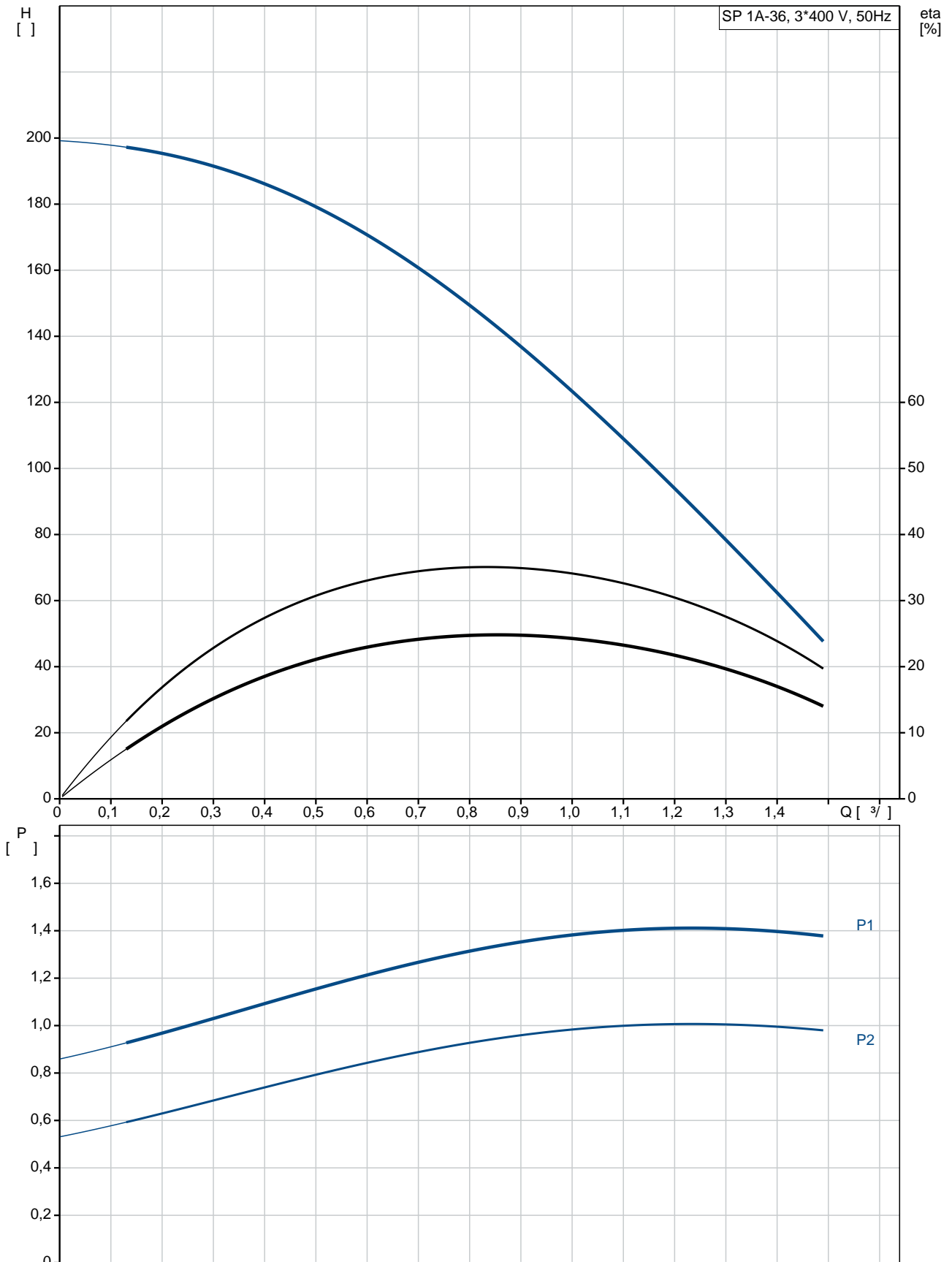

SP 1A-36  
**08101K36**  
 EAN : 5708601051241

2900 /  
 1 3/  
 126  
 36  
 NONE  
 LIPSEAL  
 CE,EAC  
 ISO9906:2012 3B  
 A  
 YES  
 T40  
 CYLINDRICAL

EN 1.4301  
 AISI AISI 304

EN 1.4301  
 AISI AISI 304

DIN W.-Nr. 1.4301  
 AISI 304

Rp1 1/4  
 4 inch

Maximum liquid temperature: 40 °C

. t 0,15 / : 40 °C

: 20 °C

: 998.2 / 3

MS402  
 GRUNDFOS

- P2: 1.1  
 ( 2), 1.1

50 Hz  
 3 x 380-400-415

3.25-3.40-3.65 A

480-480-470 %

Cos - : 0.76-0.72-0.65  
 2850-2860-2870 /

(IEC 34-5): IP68  
 (IEC 85): B

79192005

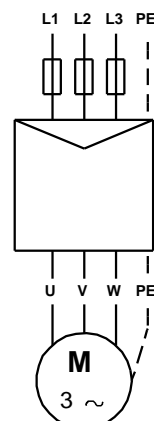
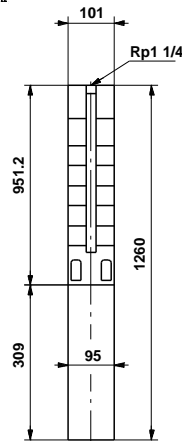
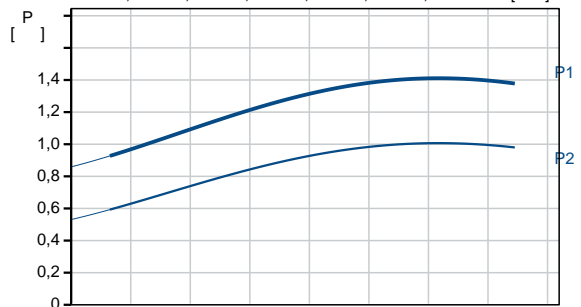
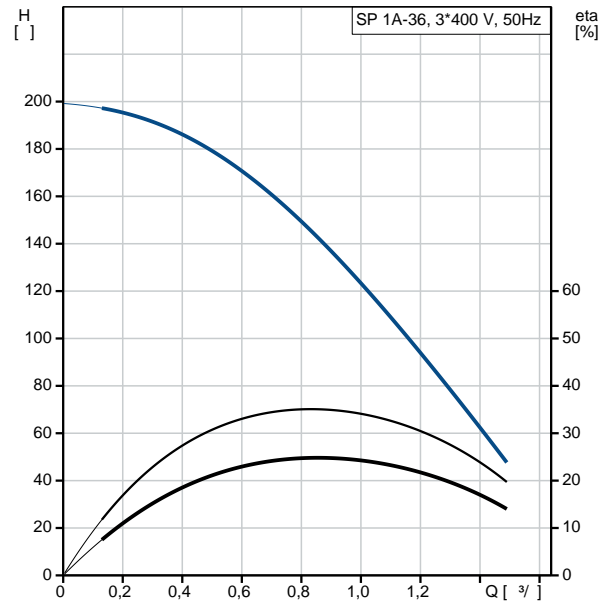

MEI :		0.70
ErP :	EuP	/ .
:		17.6
:		25
:		21.7 <sup>3</sup>
Danish VVS No.:		388311360
Swedish RSK No.:		5850290
Norwegian NRF no.:		9040806
C :	DK	
:		8413702900

**08101K36 SP 1A-36 50**

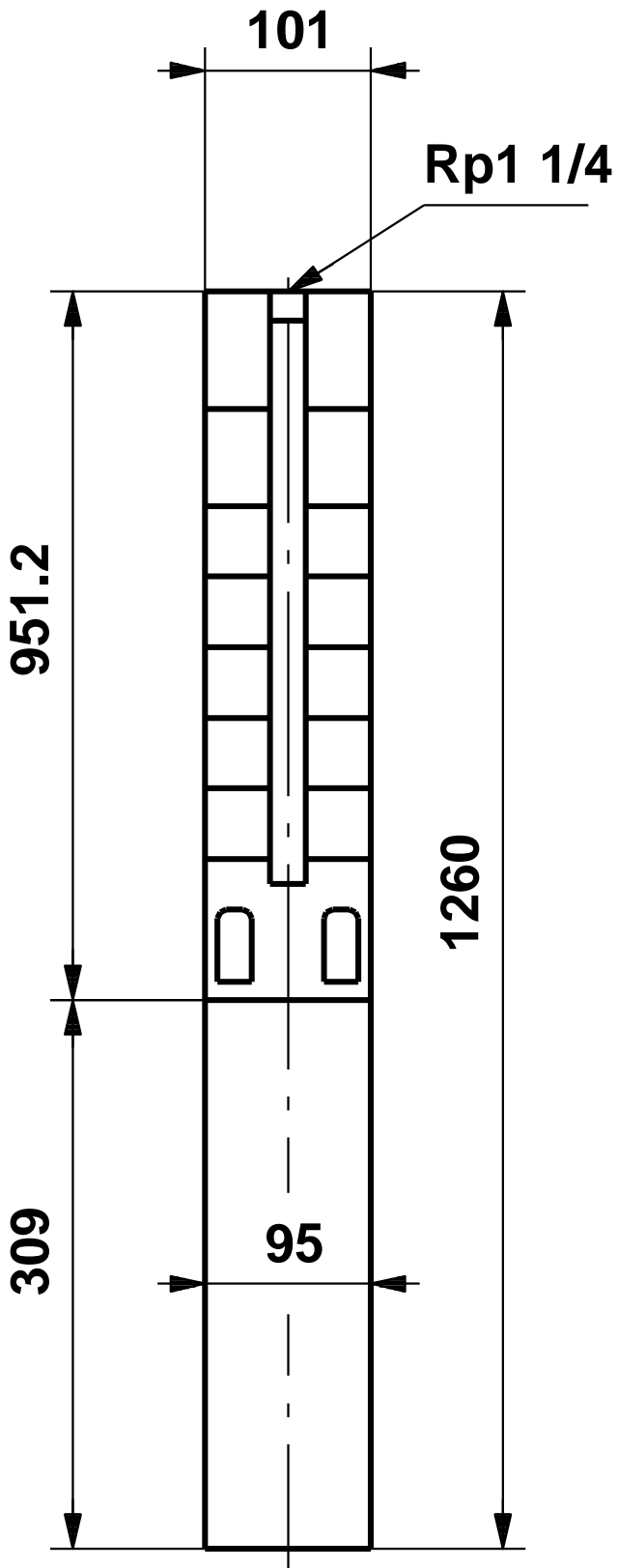

08101K36 SP 1A-36 50

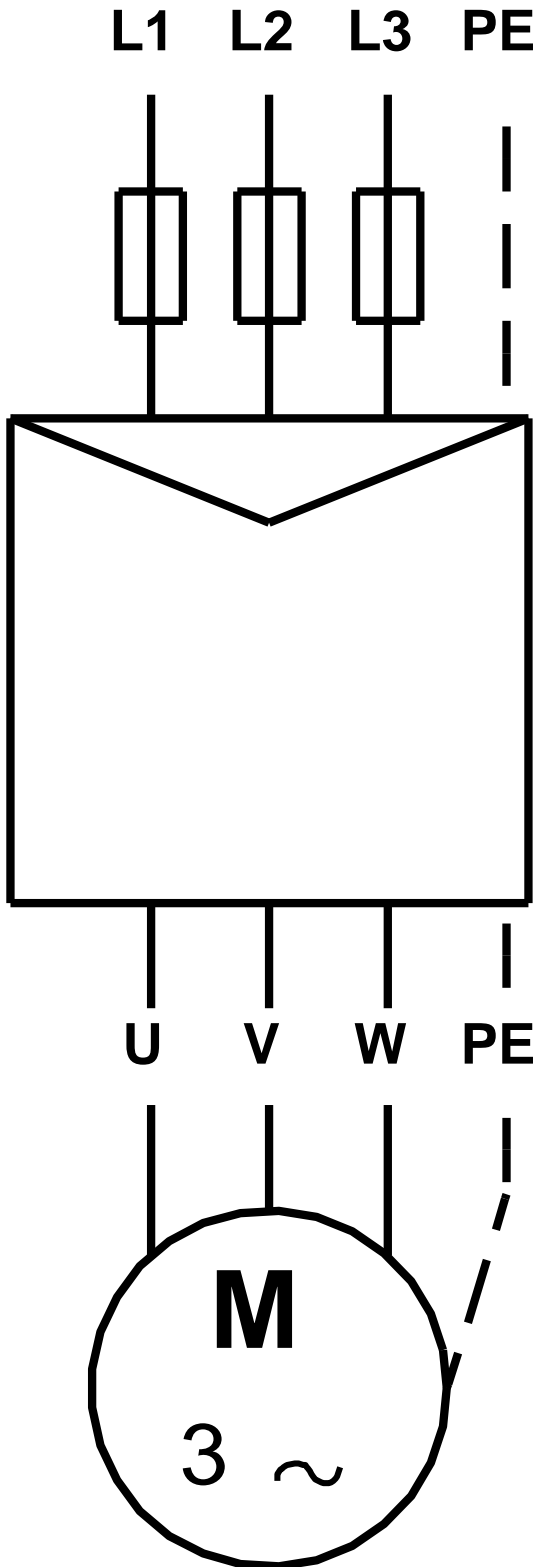

! [ ], .